



RK600

Auto Refractor / Keratometer

User's Guide

Reichert
Ophthalmic Instruments

Table of Contents

Description	Page#
Introduction	4
Warnings & Cautions	
Definitions.....	5
Symbols.....	5
Instrument Setup	
Unpacking Instructions	6
Disengage Travel Lock	7
Application of Input Power.....	7
Parts Identification	8
Icon Definition	9
Control Buttons	9
Instrument Settings	10
Instructions for Use	
Instrument Preparation	11
R/K Measurement Mode	12
Peripheral Measurement Mode.....	14
Printing Measurement Data	15
Maintenance	
Introduction.....	16
Cleaning	16
Replacement Chin Rest Pads	16
Measurement Verification	16
Fuses.....	16
Printer Paper	17
Troubleshooting	
Troubleshooting Chart	18
Error Message Chart	19
Guidance Tables	
Table 201.....	20
Table 202.....	21
Table 204.....	22
Table 206.....	23
Appendix A - General Specifications.....	24
Appendix B - RS232C Interface.....	25
Warranty	26

Table of Figures

Figure#	Description	Page#
S1	Opening Outer Box.....	6
S2	Removing Outer Box.....	6
S3	Opening Inner Box.....	6
S4	Unpacking Tray	7
S5	Accessory Tray	7
S6	Accessories	7
S7	Travel Lock	7
S8	Operator Side Identification.....	8
S9	Patient Side Identification.....	8
S10	Power Panel Identification	8
S11	Setup Menu.....	10
T1	Chin Rest Pads and Pins	11
T2	Sample Measurement Screen.....	13
T3	Sample Peripheral Measurement.....	14
P1	R/K Print-out.....	15
P2	Peripheral Print-out.....	15
M1	Open Printer Door.....	17
M2	Lift Printer Cutter	17
M3	Install Paper.....	17
M4	Close Printer Door.....	17
AB1	Appendix B - RS232C Interface.....	25

Introduction

Congratulations on your purchase of the Reichert RK600 Auto Keratometer/Refractor. The RK600 is a combination automatic keratometer/refractor which contains innovative image processing technology to obtain accurate keratometer and/or refractor measurements of a patient's eyes.

This User's Guide is designed as a training and reference manual. We recommend you carefully read and follow the steps in this guide to ensure optimum performance from your new instrument.

Please retain this guide for your reference. This guide is designed for use with product catalog number 15035 (100 to 230 VAC input voltage). Additional copies can be obtained from your authorized Reichert Distributor or our Customer Service Department, which can be contacted directly at:

- Tel#: (716) 686-4500,
- Fax#: (716) 686-4555, or
- e-mail: info@reichert.com.

© 2005 Reichert, Inc. All rights reserved.

No part of this publication may be reproduced, stored in a retrieval system, or transmitted in any form or by any means, electronic, mechanical, recording, or otherwise, without the prior written permission of Reichert, Inc.

Warnings & Cautions

Definitions

WARNING: AN INSTRUCTION THAT DRAWS ATTENTION TO THE RISK OF INJURY OR DEATH.

CAUTION: AN INSTRUCTION THAT DRAWS ATTENTION TO THE RISK OF DAMAGE TO THE PRODUCT.

Warnings

WARNING: IN ORDER TO ENSURE THAT CORRECT OPERATION OF THIS INSTRUMENT IS MAINTAINED AND TO GUARANTEE THE SAFETY AND RELIABILITY OF THE INSTRUMENT, ANY REPAIR OR SERVICE MUST BE PERFORMED BY REICHERT, INC.

WARNING: THIS INSTRUMENT SHOULD BE USED IN STRICT ACCORDANCE FOLLOWING THE INSTRUCTIONS OUTLINED IN THIS USER'S GUIDE. THE SAFETY OF THE OPERATOR AND THE PERFORMANCE OF THE INSTRUMENT CANNOT BE GUARANTEED IF USED IN A MANNER NOT SPECIFIED BY REICHERT, INC.

WARNING: THIS INSTRUMENT MUST BE PLUGGED INTO AN OUTLET WITH AN EARTH GROUND WHICH IS CONNECTED TO THE RECEPTACLE OR DAMAGE TO THE UNIT MAY OCCUR. DO NOT DISABLE OR REMOVE ANY EARTH GROUND CONNECTION ON THE INSTRUMENT OR ANY CONNECTION TO THIS INSTRUMENT OR DAMAGE AND/OR SERIOUS INJURY MAY OCCUR.

WARNING: THIS EQUIPMENT OR SYSTEM SHOULD NOT BE USED ADJACENT OR STACKED WITH OTHER EQUIPMENT AND IF ADJACENT OR STACKED USE IS NECESSARY, THE EQUIPMENT OR SYSTEM SHOULD BE OBSERVED TO VERIFY NORMAL OPERATION IN THE CONFIGURATION IN WHICH IT WILL BE USED.

Cautions

CAUTION: ANY REPAIR OR SERVICE TO THE RK600 MUST BE PERFORMED BY EXPERIENCED PERSONNEL OR DEALERS WHICH ARE TRAINED BY REICHERT SO THAT CORRECT OPERATION OF THE RK600 IS MAINTAINED.

CAUTION: THIS INSTRUMENT HAS ELECTROSTATIC DISCHARGE SENSITIVE DEVICES (ESDS) WHICH ARE SENSITIVE TO STATIC HIGH VOLTAGES STORED IN AND TRANSFERRED BY THE HUMAN BODY. OBSERVE CORRECT ESDS PRECAUTIONS OR PREMATURE MALFUNCTION OF THIS INSTRUMENT WILL OCCUR.

CAUTION: ENSURE THAT THE VOLTAGE APPLIED TO THE UNIT IS THE SAME AS THE VOLTAGE WHICH IS GIVEN ON THE DATA PLATE NEXT TO THE INPUT CORD RECEPTACLE OR DAMAGE TO THE UNIT MAY OCCUR.

CAUTION: THIS INSTRUMENT IS NOT SUITABLE FOR USE IN THE PRESENCE OF FLAMMABLE ANESTHETIC MIXTURES, SUCH AS OXYGEN OR NITROUS OXIDE.

CAUTION: DO NOT USE SOLVENTS OR STRONG CLEANING SOLUTIONS ON ANY PART OF THIS INSTRUMENT OR DAMAGE TO THE UNIT MAY OCCUR.

CAUTION: USE OF ALCOHOL ON THE LIQUID CRYSTAL DISPLAY (LCD) MAY CAUSE DAMAGE TO THE DISPLAY.

CAUTION: THE POWER CORD IS THE DISCONNECTING DEVICE FROM THE ELECTRICAL POWER SOURCE. DO NOT POSITION THE INSTRUMENT SO THAT IT IS DIFFICULT TO OPERATE OR DISCONNECT THE POWER CORD FROM THE POWER SOURCE.

Symbol Information

The following symbols appear on the instrument:



CAUTION - Caution symbol which is used to identify important instructions.



OFF (Supply) - Indicates the Power Switch is set to OFF.



ON (Supply) - Indicates the Power Switch is set to ON.



Alternating Current - Indicates that this instrument operates on alternating current.



Protective Earth - Indicates that a protective earth ground is connected where the symbol is located.



Type B Product Classification
Class 1 Equipment, Continuous Operation



Waste Electrical and Electronic Equipment (WEEE) - Indicates that this product requires disposal in a separate collection of electronic and electrical equipment according to WEEE directive 2002/96/EC (L 37/24) and is effective for products placed on the market after August 13, 2005



Date of Manufacture Symbol



Conformity with mandatory European safety requirements.



Catalog Number

Instrument Setup

Great care has been taken to deliver your new RK600 Auto Keratometer/Refractor safely to you. The container and packaging were specially designed to transport this unit. Please retain the packaging for future use if transportation is required.

Unpacking Instructions

Please unpack the instrument in the following manner: (Refer to Figures S1 thru S6)

The instrument is packaged in a shipping container to protect the instrument from damage during shipment. Inside the shipping container is an inner box, which contains the unit and the accessories. Please read the User's Guide before operating the unit.

1. Cut the straps on the outside of the box and then lift off the top of the outer box. Refer to Figure S1.
2. Lift the outer box off of its base. Refer to Figure S2.
3. Cut the straps on the inside box and open the inner box. Refer to Figure S3.
4. Remove the Manual and the Accessory Tray from the inner box. Refer to Figure S4.
5. Remove the accessories from the Accessory Tray. Refer to Figures S5 and S6. The accessories are the following:
 - Power cord
 - Dust cover
 - Spare printer paper (2 rolls)
 - Contact Lens Fixture (installed onto the Verification Eye)
 - Verification Eye
 - Box of Chin Rest Liners
 - Chin Rest Pins (2 pcs.)
 - Fuses (2 pcs., 250V @ 3A)

Note: If any of the above accessories are not included with the unit, please call your authorized Reichert distributor, or our Customer Service Department as indicated in the [Introduction](#) section of this manual.

6. Store the shipping materials in a safe place, so the packaging will be available if transportation is required in the future.



Figure S1, Opening Outer Box



Figure S2, Removing Outer

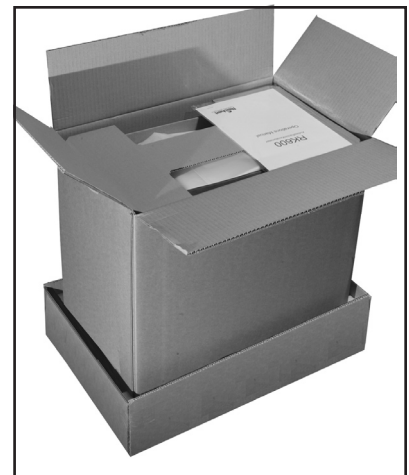

Figure S3, Opening Inner Box

Instrument Setup (Continued)

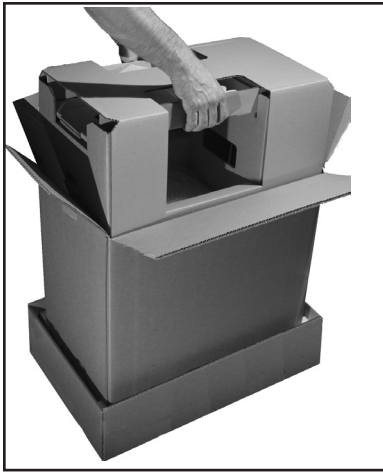

Figure S4, Unpacking Tray



Figure S5, Accessory Tray

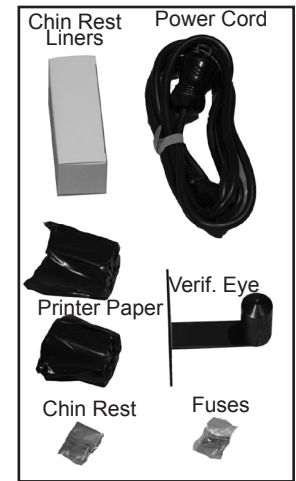

Figure S6, Accessories

Disengage Travel Lock

CAUTION: IF THE RK600 IS TRANSPORTED WITHOUT THE TRAVEL LOCK ENGAGED, DAMAGE TO THE INSTRUMENT MAY OCCUR CAUSING INCORRECT READINGS AND/OR FAILURE OF ITS ELECTRONIC OR MECHANICAL PARTS.

- Place the RK600 in the location where it will be utilized.
- The Travel Lock is located on the lower left front corner of the instrument. Rotate the knob counterclockwise to disengage the Travel Lock. Refer to Figure S7.

Note: If at any time this instrument is relocated, engage the Travel Lock prior to moving the instrument. If this instrument is transported to a different location, engage the Travel Lock and then secure the instrument into its original packaging.



Figure S7, Travel Lock

Application of Input Power

CAUTION: MAKE SURE THAT THE VOLTAGE APPLIED TO THE UNIT IS THE SAME AS THE VOLTAGE GIVEN ON THE DATA PLATE NEXT TO THE INPUT CORD RECEPTACLE OR DAMAGE TO THE UNIT MAY OCCUR.

- After the unit is secure and the travel lock is disengaged, apply power to the instrument using the Power Cord which was contained in the Accessory Tray.
- Read and fully understand the User's Guide and the Quick Reference Card before operating this instrument.

Instrument Setup (Continued)

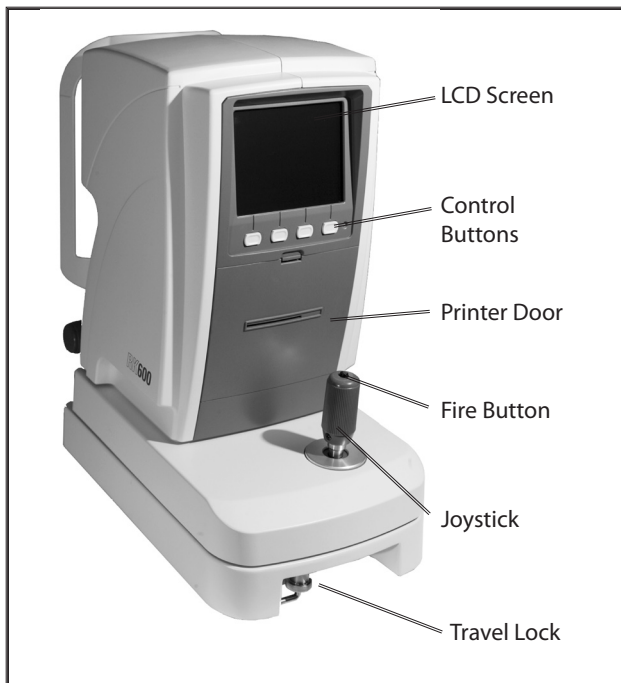

Figure S8, Operator Side Identification

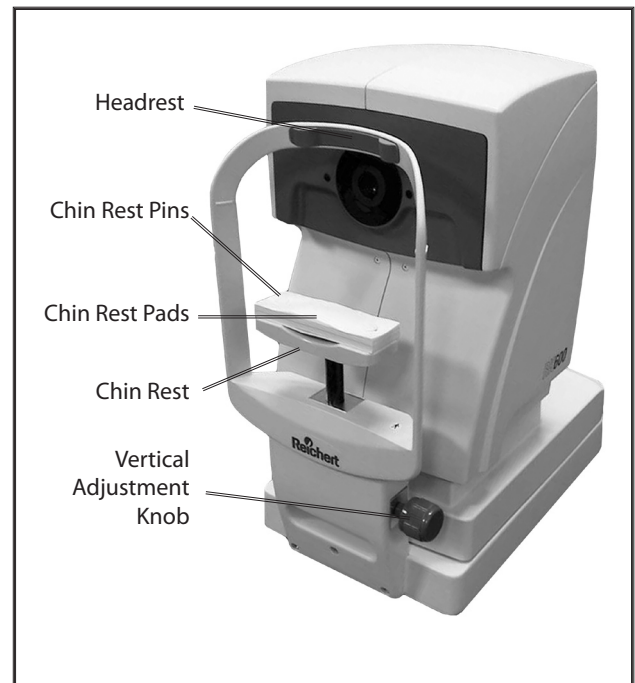

Figure S9, Patient Side

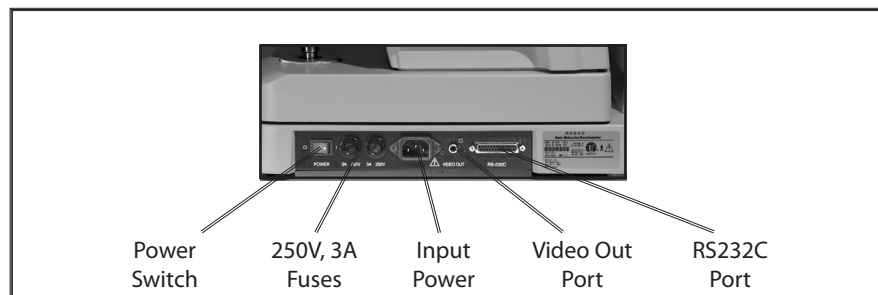

Figure S10, Power Panel

Parts Identification

LCD Screen:

Operator display providing measurement data.

Control Buttons:

Buttons for selecting options on the Operator Display.

Printer Door:

Printer door (push to open) to access travel lock and printer paper.

Joystick:

Positioning device used for alignment.

Fire Button:

Button that is pressed in the Manual mode to acquire a measurement.

Travel lock:

Locking mechanism which secures the internal parts of the unit during shipment.

Headrest:

Horizontal reference point for the forehead.

Chin Rest Pins:

Pins that secure the Headrest Pads onto the Chin Rest.

Chin Rest Pads:

Disposable pads for use on the chin rest.

Chin Rest:

Adjustable positioning point for the patient's chin.

Vertical Adjustment Knob:

Knob that adjusts the height of the Chin Rest.

Power Switch:

ON/OFF switch that controls input power to the unit.

Fuses:

250V, 3A fuses (2pcs. per unit) for overcurrent protection.

Input Power:

Interface for connecting input power to the unit.

Video Out Port:

interface for connecting an external video monitor.

RS-232C Port:

Communication port which contains printer data.

Instrument Setup (Continued)

Icon Definition

The RK600 incorporates a user-friendly icon/menu-based operating system which will increase the speed of measurements, training, and use. Below are the Icons which are used during the operation of this instrument.

<u>Icon</u>	<u>Icon Description</u>
	If this icon is shown, the refraction data is displayed in the 1/8 diopter mode.
	If this icon is shown, the refraction data is displayed in the 1/4 diopter mode.
	When this icon is displayed, the plus (+) cylinder mode is active.
	When this icon is displayed, the minus (-) cylinder mode is active.
	When this icon is displayed, either the plus (+) or the minus (-) mode as "best" determined by the instrument is active.
	Displays that the unit is ready to take a left eye measurement.
	Displays that the unit is ready to take a right eye measurement.
	The number displayed to the right of this icon is the keratometric reading.
	The number displayed to the right of this icon is the refraction reading.
	Indicates a vertex distance of zero (0) millimeters (contact lens prescription).
	Indicates a vertex distance of 10 millimeters.
	Indicates a vertex distance of 12 millimeters.
	Indicates a vertex distance of 13.5 millimeters.
	Indicates a vertex distance of 15 millimeters.
<u>Icon</u>	<u>Control Buttons</u>
	Press this button to erase the current data displayed on the screen.
	Measurement mode for Refraction, and/or Keratometric, or Peripheral mode. Options are: R/K (Refraction and Keratometric), R (Refraction only), K (Keratometric only, or P.K. (Peripheral Keratometric) measurements.
	When this button is depressed, the setup menu is displayed to change the system options.
	Press this button when a print-out is desired. For an automatic print-out after readings are acquired, go to the setup menu and set the print option to "auto."
	Press this button to change to the next position (peripheral measurement mode only).

Instructions for Use

Instrument Preparation

The RK600 is an advanced electronic refractometer/keratometer which quickly acquires precise data of the human eye. The information below will assist you in detailing the initial steps to obtain optimum performance of this instrument.

Perform the following steps after removing the RK600 from its shipping container.

1. Install the unit in its permanent location and then ensure that the Travel Lock has been disengaged.
2. Remove the plastic protector that is installed onto the LCD Screen to prevent scratches and contaminants on the screen.
3. Install an adequate supply of Chin Rest Pads onto the Chin Rest and secure them with the Chin Rest Pins. Refer to Figure T1.
4. Install the Printer Paper as indicated in the [Maintenance](#) section of this manual.

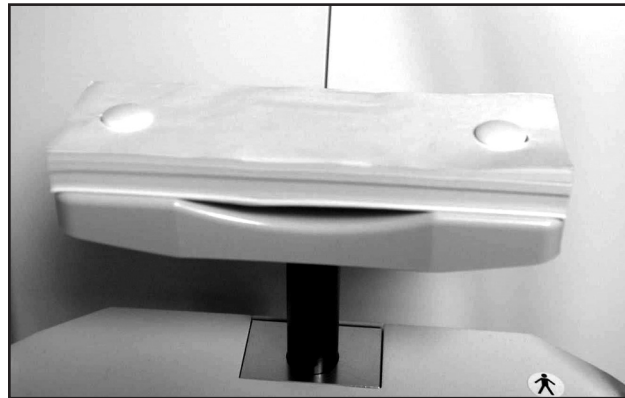

Figure T1. Chin Rest Pads and Pins

Instructions for Use (Continued)

R/K Measurement Mode

Measurement Modes

The RK600 has six measurement modes:

R/K	Refraction and keratometric data
R	Refraction only data
K	Keratometric only data
P.K.	Peripheral keratometric data.
IOL R/K	Refraction and keratometric data, utilizing IOL filtering
IOL R	Refraction only data, utilizing IOL filtering

Note: When power is applied to the RK600, the instrument automatically displays the last used measurement mode.

Note: When acquiring IOL patient data, it is recommended that the IOL option be used. Using IOL filter options for non-IOL patients may cause occasional measurement difficulty for patients with reduced pupil diameters.

The following information describes the correct method for acquiring refractor and keratometer measurements using the RK600.

1. Ask the patient to place their chin on the Chin Rest and then move their head forward until their forehead is placed against the Headrest.
2. Adjust the Vertical Alignment Knob and move the Joystick until the patient can view the fixation target (the house) with their right eye.
3. Twist the Joystick until the pupil is vertically centered on the LCD Screen.
4. Move the Joystick left, right, in and out until the circle is in focus and the PLUS icon (+) is in the center of the circle.
 - If the instrument is set for the AUTO mode, the measurements will automatically be acquired when alignment is achieved.
 - If the instrument is set for the MANUAL mode, the Fire Button must be depressed to acquire a measurement when alignment is achieved.
5. Repeat the above steps for the left eye.
6. Press the PRINT button if a print-out of the measurements is desired .

Instructions for Use (Continued)

R/K Measurement Mode (Continued)

Measurement Data

Data for the measurements acquired in the R/K, R, or K measurement modes is displayed on the LCD Screen. A summary of the data is given below. Refer to Figure T2.

- R** Indicates refractive measurements.
- K** Indicates keratometric measurements.
- S Sphere values
- C Cylinder Values
- A Axis angle
- R1 Radius of curvature (max)
- R2 Radius of curvature (min)
- PD Pupillary distance
- NPD Near pupillary distance*

* Displayed only when a value is set for the W-D (working distance) in the SETUP mode.



Figure T2. Sample Measurement Screen

Instructions for Use (Continued)

Peripheral Measurement Mode

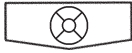

Peripheral measurements are measurements of the eye which are taken at its center and four equidistant points around the eye to determine the curvature of the cornea. The peripheral section of this instrument acquires five measurements; one at the center, and four measurements (superior, temporal, inferior, and nasal) which are equidistant from the center of the eye and each other. To acquire a peripheral measurement, the patient fixates on the peripheral diode and the operator aligns the instrument to the center of the target.

Perform the following steps to take a peripheral measurement:

1. Press the button below the MODE button until the PERIPHERAL icon is shown for the peripheral mode. In this mode, the peripheral icon is displayed on the LCD and the active position is indicated by the blinking segment.
2. The middle segment is the first blinking segment. Align the instrument to the right eye and press the FIRE button (on top of the Joystick) when the PLUS (+) icon is in focus (IN and OUT distance) and is at the center of the circle on the Operator Screen.
3. Instruct the patient to fixate on the red LED. When the patient is ready, align the PLUS (+) icon so that it is in focus (IN and OUT distance) and is at the center of the circle on the Operator Screen, and then press the FIRE button.

Note: The red LED that the patient observes is opposite in position to the blinking segment of the peripheral icon. The blinking segment relates to the position on the eye that is measured (when the patient looks down, the area above the center of the eye is measured).

4. Repeat the above step until all four peripheral measurements are acquired.
5. Repeat the above steps for the other (left) eye.

The definitions of the peripheral data categories on the screen (or print-out) are as follows:

- C = Measurement at the center of the eye
- T = Measurement at 30 degrees from the center of the eye on temporal side of the eye.
- N = Measurement at 30 degrees from the center of the eye on nasal side of the eye.
- S = Measurement at 30 degrees from the center of the eye on superior side of the eye.
- I = Measurement at 30 degrees from the center of the eye on inferior side of the eye.
- e = Eccentricity of the eye, average total.
- H = Eccentricity of the eye in the horizontal meridian.
- V = Eccentricity of the eye in the vertical meridian.

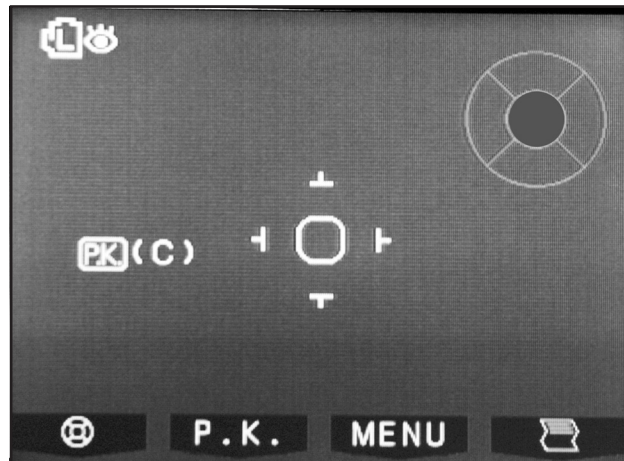

Figure T3. Sample Peripheral Measurement

Instructions for Use (Continued)

Printing Measurement Data



The print function in this instrument has three options.

- Automatic mode - This option automatically prints out the data after all measurements are taken on both the right and left sides.
- Manual mode - This option prints out the data only when the print button is pressed.
- Additionally, the printer can be set to the OFF mode. In this mode the printer does not print even if the print button is pressed, and the data is sent to the serial port instead of the printer.

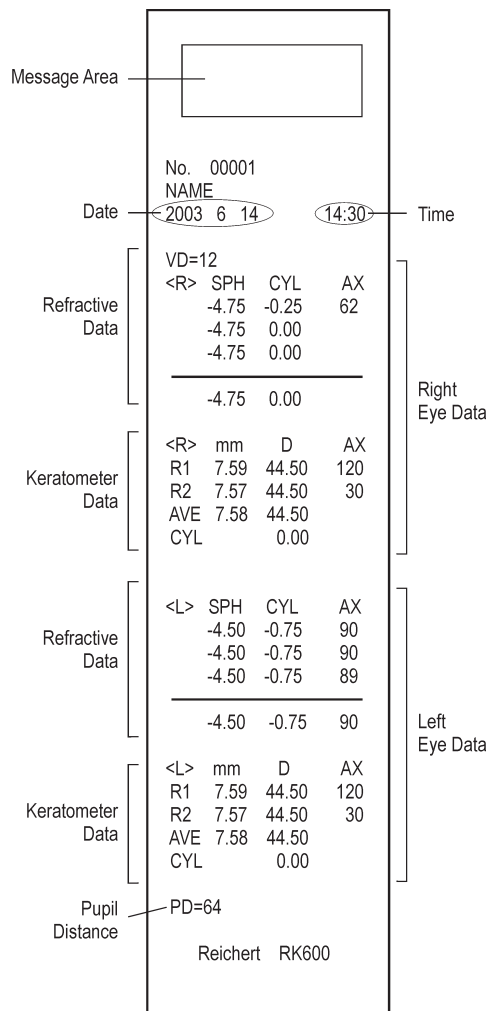

Figure P1. R-K Print-out

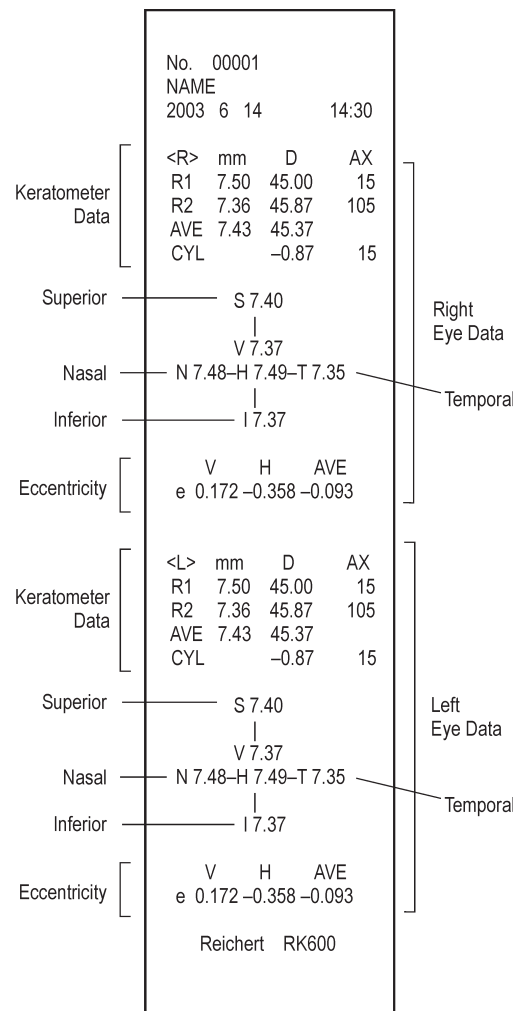

Figure P2. Peripheral Print-out

Maintenance



Introduction

The RK600 requires very little routine maintenance due to its advanced design. For instance, there are no bulbs or lamps to change.

If you have questions regarding maintenance, contact your local distributor, or our Customer Service Department directly at (716) 686-4500.

Cleaning

CAUTION: DO NOT USE ALCOHOL OR ANY SOLVENTS ON ANY EXTERNAL SURFACE OF THE INSTRUMENT OR DAMAGE TO THE PAINTED OR COATED SURFACE MAY OCCUR.

Joystick

Clean external surfaces of the Joystick using a clean, soft cloth that is only lightly dampened with a mild detergent solution (1 cc of liquid dish soap to one liter of clean filtered water (e.g., filtered below 5 microns)).

Operator Display

Clean the Operator Display using a clean, soft cloth that is only lightly dampened with a mild detergent solution (1 cc of liquid dish soap to one liter of clean filtered water (e.g., filtered below 5 microns)).

Patient Mire Window

Clean the Patient Mire Window using a clean, soft cloth that is only lightly dampened with a mild detergent solution (1 cc of liquid dish soap to one liter of clean filtered water (e.g., filtered below 5 microns)).

Instrument Covers

Clean external surfaces of Instrument Covers using a clean, soft cloth that is only lightly dampened with a mild detergent solution (1 cc of liquid dish soap to one liter of clean filtered water (e.g., filtered below 5 microns)).

Replacement Chin Rest Pads

For hygienic reasons, replaceable Chin Rest Pads are included with this instrument. After a patient is measured, it is recommended by Reichert that the top Chin Rest Pad be discarded so that hygienic conditions are maintained.

Measurement Verification

Included with this instrument is a Model Eye that may be used to simulate a measurement on a patient. Use this Model Eye when a performance check of the unit is desired. To acquire a measurement using this eye, remove the Chin Rest Pads and install the Model Eye onto the Chin Rest. Measurements acquired using this eye must be within the tolerances indicated on the Model Eye. If the measurements are not within tolerance, check the mounting and position of the Model Eye then acquire another measurement. If the measurement is still not within tolerance, contact your authorized Reichert distributor, or the Reichert Customer Service Department as indicated in the [Introduction](#) section of this manual.

Fuses

Fuses are located next to the power inlet (Refer to page 8). Only replace with fuses recommended by Reichert.

Maintenance (Continued)

Printer Paper

Installation of the printer paper is quick and easy.

1. Open the Printer Door by pushing the Door Latch down and pulling forward. Refer to Figure M1.
2. Lift the Printer Cutter Assembly up. Refer to Figure M2.
3. Install the Printer Paper behind the Roller Bar and turn the Roller Bar Knob so that the paper is pushed through the Roller Bar. Refer to Figure M3.
4. Push the Printer Paper through the cutter bar of the Printer Cutter Assembly. Refer to Figure M3.
5. Return the Printer Cutter to its original position and gently pull the paper through the Printer Cutter to allow the Printer Paper to be installed through the Printer Door. Refer to Figure M4.
6. Close the Printer Door and gently pull on the Printer Paper so that the Printer Paper is not stuck between the printer and the door. Refer to Figure M4.



Figure M1, Open Printer Door

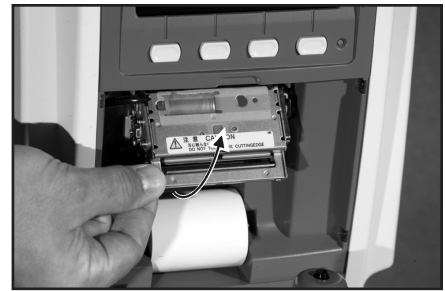

Figure M2, Lift Printer Cutter

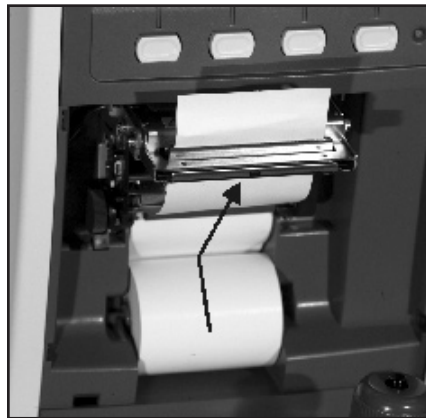

Figure M3, Install Paper

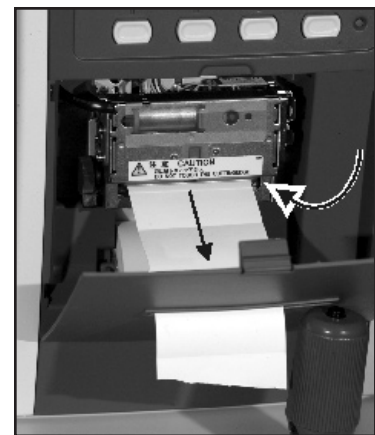

Figure M4, Close Printer Door

Troubleshooting (Continued)

Troubleshooting Chart

The following chart provides details of common difficulties and solutions for the RK600 .

ERROR	MESSAGE	REMEDY
SYSTEM	<p>Screen blank.</p> <p>Unit will not move left/right or in/out.</p> <p>Joystick will not move easily.</p> <p>Clock/date incorrect.</p> <p>Fuse is blown when power is applied.</p>	<p>Unit may be in the “sleep” mode, push any button to continue.</p> <p>Travel lock may be engaged. Disengage the travel lock.</p> <p>Contact your Reichert Authorized Dealer for repair of this instrument.</p> <p>Change settings in setup. Battery in the unit is out of power.</p> <p>Contact your Reichert Authorized Dealer for repair of this instrument.</p>
PRINTER	<p>Will not print.</p> <p>Paper jams in printer.</p> <p>No power.</p>	<p>Out of paper. Printer not turned on in setup. Paper installed upside down.</p> <p>Paper installed incorrectly. Re-install paper as indicated in the manual.</p> <p>Check fuses and/or power outlet/ power cord.</p>

If problems still persist, contact your local dealer or Reichert, Inc.

NOTE: Circuit diagrams, component parts list descriptions and calibration instructions are available only to the qualified personnel.

Troubleshooting (Continued)

The following chart provides details of common error messages for the RK600.

MESSAGE	CAUSE	REMEDY
RETRY	Patient eye moved. Wrong alignment.	Have the patient remain still and fixate on the target. Realign the patient and take a new measurement.
SPH OVER	Exceeded sphere measurement range ($\pm 25D$).	Measure within the sphere range.
CYL OVER	Exceeded cylinder measurement range ($\pm 10D$).	Measure within the cylinder range.
MOTOR FAULT	Motor fault in motor control system.	Reset power to the unit and take a new measurement.
EEPROM FAULT	EEPROM failed to initialize.	Reset power to the unit.
PRINTER CUTTER HEAD UP	Printer cutter head is up or not engaged.	Open and then close the printer cutter head to reset the sensor.
PRINTER HEAD OVER HEAT	Printer head is over-heating.	Contact your Reichert Authorized Dealer for repair of this instrument.
PRINTER CUTTER FAULT	Paper jam in the printer .	Clean out the printer jam.
PAPER EMPTY	No printer paper in the printer.	Install printer paper in the printer as indicated in this manual.

If problems still persist, contact your local dealer or Reichert, Inc.

NOTE: Circuit diagrams, component parts list descriptions and calibration instructions are available only to qualified personnel.

Guidance Tables

Table 201

Table 201 - Guidance and Manufacturer's Declaration - Emissions
All Equipment and Systems

Guidance and Manufacturer's Declaration - Emissions		
The 15035 Rev. C is intended for use in the electromagnetic environment specified below. The customer or user of the 15035 Rev. C should ensure that it is used in such an environment.		
Emissions Test	Compliance	Electromagnetic Environment - Guidance
RF Emissions CISPR 11	Group 1	The 15035 Rev. C uses RF energy only for its internal function. Therefore, it's RF emissions are very low and are not likely to cause any interference in nearby electronic equipment.
RF Emissions CISPR 11	Class A	The 15035 Rev. C is suitable for use in all establishments other than domestic and those directly connected to the public low-voltage power supply network that supplies buildings used for domestic purposes.
Harmonics IEC 61000-3-2	Class A	
Flicker IEC 61000-3-3	Complies	

Guidance Tables

Table 202

Table 202 - Guidance and Manufacturer's Declaration - Immunity
All Equipment and Systems

Guidance and Manufacturer's Declaration - Immunity			
The 15035 Rev. C is intended for use in the electromagnetic environment specified below. The customer or user of the 15035 Rev. C should ensure that it is used in such an environment.			
Immunity Test	IEC 60601 Test Level	Compliance Level	Electromagnetic Environment - Guidance
ESD IEC 61000-4-2	±6kV Contact ±8kV Air	±6kV Contact ±8kV Air	Floors should be wood, concrete or ceramic tile. If floors are synthetic, the r/h should be at least 30%
EFT IEC 61000-4-4	±2kV Mains ±1kV I/Os	±2kV Mains ±1kV I/Os	Mains power quality should be that of a typical commercial or hospital environment.
Surge IEC 61000-4-5	±1kV Differential ±2kV Common	±1kV Differential ±2kV Common	Mains power quality should be that of a typical commercial or hospital environment.
Voltage Dips/Dropout IEC 61000-4-11	>95% Dip for 0.5 Cycle 60% Dip for 5 Cycles 30% Dip for 25 Cycles >95% Dip for 5 Seconds	>95% Dip for 0.5 Cycle 60% Dip for 5 Cycles 30% Dip for 25 Cycles >95% Dip for 5 Seconds	Mains power quality should be that of a typical commercial or hospital environment. If the user of the 15035 Rev. C requires continued operation during power mains interruptions, it is recommended that the 15035 Rev. C be powered from an uninterruptible power supply or battery.
Power Frequency 50/60 Hz Magnetic Field IEC 61000-4-8	3A/m	3A/m	Power frequency magnetic fields should be that of a typical commercial or hospital environment.

Guidance Tables

Table 204

Table 204 - Guidance and Manufacturer's Declaration - Emissions
Equipment and Systems that are NOT Life-Supporting

Guidance and Manufacturer's Declaration - Emissions			
The 15035 Rev. C is intended for use in the electromagnetic environment specified below. The customer or user of the 15035 Rev. C should ensure that it is used in such an environment.			
Immunity Test	IEC 60601 Test Level	Compliance Level	Electromagnetic Environment - Guidance
Conducted RF IEC 61000-4-6	3 Vrms 150 kHz to 80 MHz	(V1)=3Vrms	<p>Portable and mobile communications equipment should be separated from the 15035 Rev. C by no less than the distances calculated/listed below:</p> $D=(3.5/V1)(\text{Sqrt } P)$ $D=(3.5/E1)(\text{Sqrt } P)$ <p>80 to 800 MHz</p>
Radiated RF IEC 61000-4-3	3 V/m 80 MHz to 2.5 GHz	(E1)=3V/m	$D=(7/E1)(\text{Sqrt } P)$ <p>800 MHz to 2.5 GHz</p> <p>Where P is the max power in watts and D is the recommended separation distance in meters.</p> <p>Field strengths from fixed transmitters, as determined by an electromagnetic site survey, should be less than the compliance levels (V1 and E1).</p> <p>Interference may occur in the vicinity of equipment containing a transmitter.</p>

Guidance Tables

Table 206

Table 206 - Recommended Separation Distances between portable and mobile RF Communications equipment and the 15035 Rev. C Equipment and Systems that are NOT _____ Life-Supporting

Recommended Separations Distances for the 15035 Rev. B			
<p>The 15035 Rev. C is intended for use in the electromagnetic environment in which radiated disturbances are controlled. The customer or user of the 15035 Rev. C can help prevent electromagnetic interference by maintaining a minimum distance between portable and mobile RF Communications Equipment and the 15035 Rev. C as recommended below, according to the maximum output power of the communications equipment.</p>			
Max Output Power (Watts)	Separation (m) 150kHz to 80 MHz D=1.1667 (Sqrt P)	Separation (m) 80 to 800 MHz D=1.1667 (Sqrt P)	Separation (m) 800MHz to 2.5GHz D=2.3333(Sqrt P)
0.01	0.11667	0.11667	0.23333
0.1	0.36894	0.36894	0.73785
1	1.1667	1.1667	2.3333
10	3.6894	3.6894	7.3785
100	11.667	11.667	23.333

Appendix A - General Specifications

Keratometer

Radius of Curvature:	5.00 mm thru 10.00 mm (0.01 mm steps)
Corneal Power:	33.75D thru 67.50D (0.12D, 0.25D steps)
Cylinder:	0 thru 9.0D
Axis:	0° thru 180° (1° steps)
Peripheral	4 points at 30° from apex

Refractor

Sphere	-25.00D thru +25.00D (0.01D, 0.12D, 0.25D steps)
Cylinder	-10.00 thru +10.00D
Axis	0° thru 180° (1° steps)

Measurement Accuracy

Sphere	-10.00D thru +10.00D = ±0.25D, else 0.50D
Cylinder	±0.25D

Other

PD Range	85mm, 1mm steps
Pupil Diameter Min.	2.3mm (> 2.3mm increases standard measurement error)
Vertical Adjustment (Chin Rest)	±30.0mm

Physical Data

Height:	17.2 in. (437mm)
Depth:	16.6 in. (422mm)
Width:	9.4 in. (240mm)
Weight, unpacked:	33 lbs. (15.0 kg)

Electrical Data

Voltage (nominal)	100 ~ 240 VAC
Power	80 VA
Frequency	50/60 Hz
Fuses	250 VAC, 3 Amps

Transportation & Storage

This instrument can withstand the following conditions while packed for transportation or storage:

- an atmospheric pressure range of 760 mmHg (101 kPa) thru 528 mmHg (70.4 kPa)
- an ambient temperature range from, -10 °C thru +60 °C
- a relative humidity range of 30% thru 85%

Note: Operating conditions are recommended from +10 °C thru +40 °C at a relative humidity of 40% thru 70%.

Note: The extreme high or low storage conditions shown above should not exceed 15 weeks.

Disposal

This product does not generate any environmentally hazardous residues. At the end of product life, follow local laws and ordinances regarding proper disposal of this equipment.

Applicable Laws and Standards

Law	Electromagnetic Compatibility Directive 89/336/EEC Low Voltage Directive 72/23/EEC Waste Electrical and Electronic Equipment (WEEE) Directive 2002/96/EC
Standard	Safety of a device - EN 61010-1: 2001 Electromagnetic Compatibility - EN 61326-1: 1997, Amendment A2: 2001 Class A

Appendix B - RS232C Interface

Connections from the RK600 to a computer are possible using the following settings:

Baud Rate: 384000, 19200, 9600, 4800, or 2400 bps (bits per second)

Character (word): 8, or 7

Parity: Odd, Even, or None

Stop Bits: 2, or 1

The connections from the RK600 to the computer are shown in the following diagram :

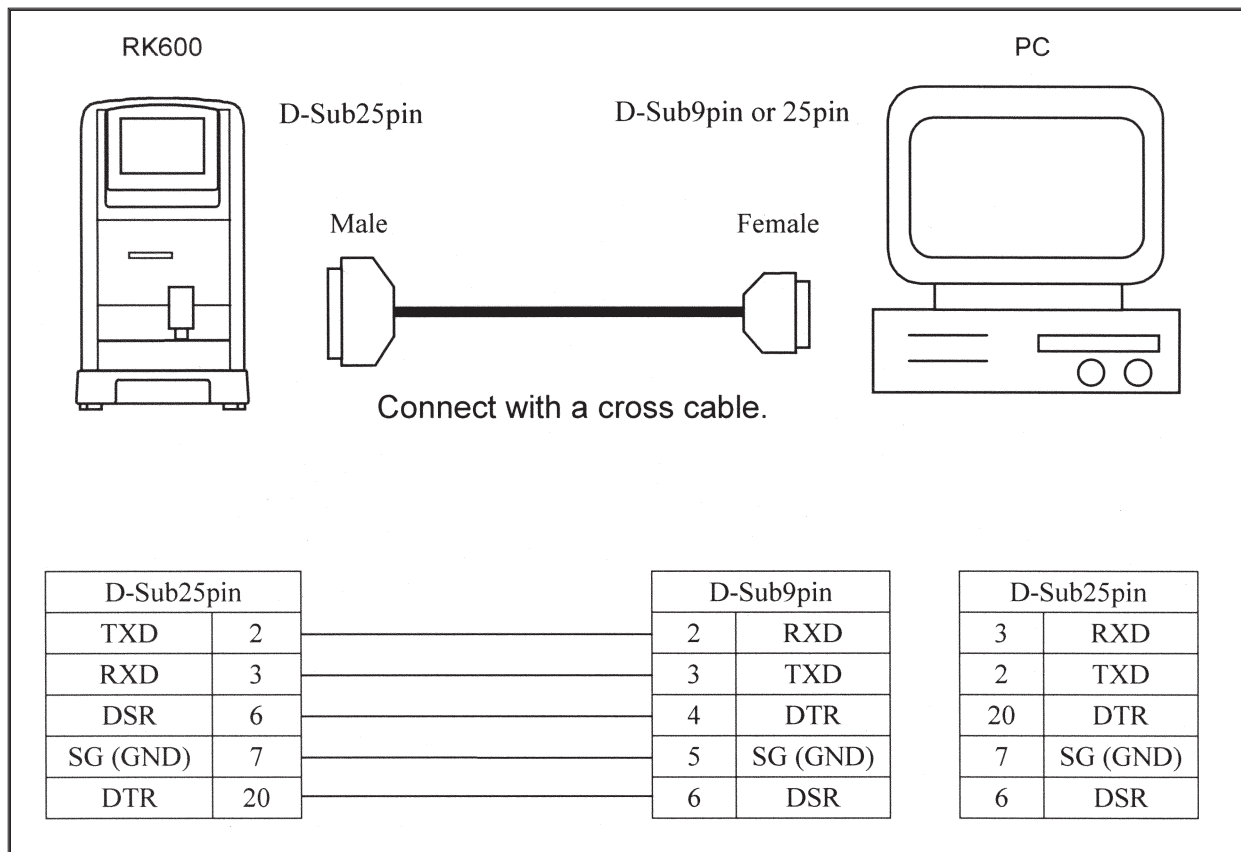

Figure AB1. RS232C Interface

Warranty

This product is warranted by Reichert, Inc. (Reichert) against defective material and workmanship under normal use for a period of one year from the date of invoice to the original purchaser. (An authorized dealer shall not be considered an original purchaser.) Under this warranty, Reichert's sole obligation is to repair or replace the defective part or product at Reichert's discretion.

This warranty applies to new products and does not apply to a product which has been tampered with, altered in any way, misused, damaged by accident or negligence, or which has the serial number removed, altered or effaced. Nor shall this warranty be extended to a product installed or operated in a manner not in accordance with the applicable Reichert instruction manual, nor to a product which has been sold, serviced, installed or repaired other than by a Reichert factory, Technical Service Center, or authorized Reichert, Inc. Dealer.

Lamps, bulbs, charts, cards and other expendable items are not covered by this warranty.

All claims under this warranty must be in writing directed to the Reichert factory, Technical Service Center, or authorized instrument dealer making the original sale and must be accompanied by a copy of the purchaser's invoice with serial numbers. Any product returned for service must have a Return Material Authorization (RMA) and be packed in factory packaging.

This warranty is in lieu of all other warranties implied or expressed. All implied warranties of merchantability or fitness for a particular use are hereby disclaimed. No representative or other person is authorized to make any other obligations for Reichert. Reichert shall not be liable for any special, incidental, or consequent damages for any negligence, breach of warranty, strict liability or any other damages resulting from or relating to design, manufacture, sale, use or handling of the product.

PATENT WARRANTY

If notified promptly in writing of any action brought against the purchaser based on a claim that the instrument infringes a U.S. Patent, Reichert will defend such action at its expense and will pay costs and damages awarded in any such action, provided that Reichert shall have sole control of the defense of any such action with information and assistance (at Reichert's expense) for such defense, and of all negotiation for the settlement and compromise thereof.

PRODUCT CHANGES

Reichert reserves the right to make changes in design or to make additions to or improvements in its products without obligation to add such to products previously manufactured.

CLAIMS FOR SHORTAGES

We use extreme care in selection, checking, rechecking and packing to eliminate the possibility of error. If any shipping errors are discovered:

1. Carefully go through the packing materials to be sure nothing was inadvertently overlooked when the unit was unpacked.
2. Call the dealer you purchased the product from and report the shortage. The materials are packed at the factory and none should be missing if the box has never been opened.
3. Claims should be filed within 30 days.

CLAIMS FOR DAMAGES IN TRANSIT

Our shipping responsibility ceases with the safe delivery in good condition to the transportation company. Claims for loss or damage in transit should be made promptly and directly to the transportation company.

If, upon delivery, the outside of the packing case shows evidence of rough handling or damage, the transportation company's agent should be requested to make a "Received in Bad Order" notation on the delivery receipt. If within 48 hours of delivery, concealed damage is noted upon unpacking the shipment and no exterior evidence of rough handling is apparent, the transportation company should be requested to make out a "Bad Order" report. This procedure is necessary in order for the dealer to maintain the right of recovery from the carrier.

Notes

Reichert, Inc.
3362 Walden Ave
Depew, NY 14043
USA

Toll Free: 888-849-8955
Phone: 716-686-4500
www.reichertoi.com

Reichert GmbH
Hubertusstrasse 2
D-82229 Seefeld
Germany

Tel: +49-8152-993530

ISO-9001 Certified

CE 0120

15035-101-Rev. D