

---

RETINAL CAMERA  
**TRC-50X**

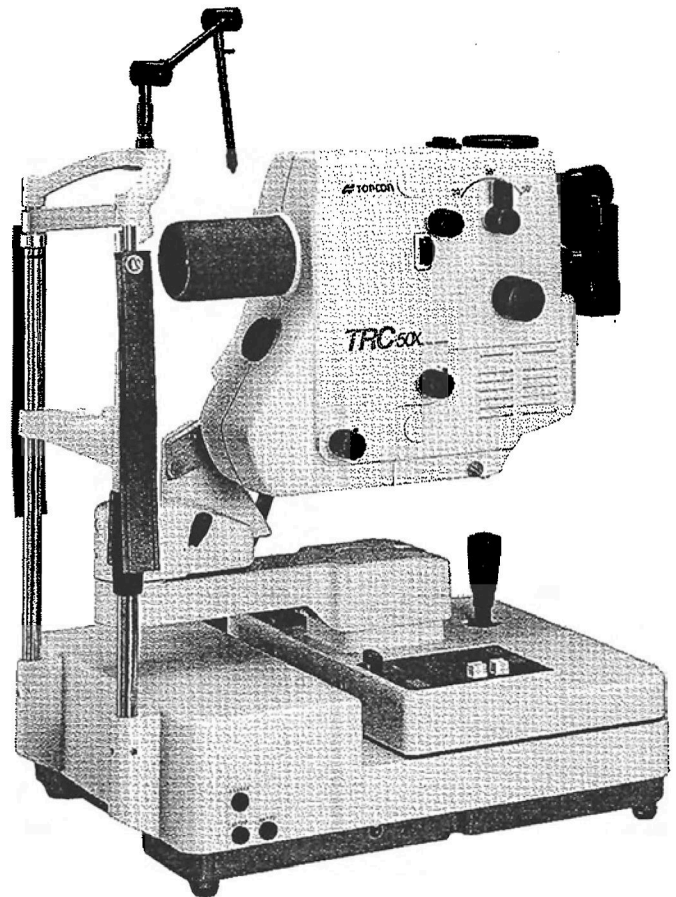

Thank you for your purchasing the TOPCON Retinal Camera TRC-50X.  
To get the best use from the instrument, please carefully read these instructions  
and place it in a convenient location for future reference.

### **PRECAUTIONS**

1. As this instrument is a precision device, install it in a location where temperature and humidity are controlled for a normal living environment. Avoid locations that are in direct sunlight or susceptible to dust.
2. For smooth operation of this device, do not set the instrument on an uneven floor or a surface susceptible to vibration.
3. Properly connect all cords before using.
4. Always keep the installation area clean. Turn the power OFF when the unit is not in use. Attach the objective lens cap and protect with the dust cover.
5. Ground the primary side of the power supply.
6. As the device will not operate properly with a low or high voltage, use the instrument with a power source within a range of  $\pm 10\%$  of the rated voltage.
7. As the objective lens has a special coating, avoid wiping the lens surface too strongly. Refer to the instructions for cleaning lenses explained under section 4.2 on page 22.
8. Avoid touching the 35mm camera mirror which has a special coating.
9. When attaching or removing the 35mm camera or other accessories to the instrument with a tilt device, tighten the tilt locking lever 19 first.
10. TOPCON takes no responsibility for the performance of units which have undergone unauthorized disassembly or alteration in any way.
11. If you experience instrument malfunction, contact your authorized dealer or TOPCON directly.

# CONTENTS

<b>1. NOMENCLATURE AND FUNCTIONS</b> .....	1
1.1 Main Body .....	1
1.2 Control Unit .....	3
1.3 35mm Motor Driven Camera Body .....	4
1.4 Power Supply Unit .....	5
1.5 Accessories .....	5
<b>2. ASSEMBLY</b> .....	6
2.1 Components .....	6
2.2 Assembling procedure .....	7
2.3 Checking the primary voltage .....	8
2.4 Checking the power supply outlet .....	8
2.5 Checking power frequency .....	8
2.6 Checking tilt balance .....	9
<b>3. PHOTOGRAPHY</b> .....	10
3.1 Preparations .....	10
3.1.1 General preparations .....	10
3.1.2 Loading 35mm camera with film: When loading film into camera mounted onto the body .....	12
3.1.3 Loading 35mm camera with film: When loading film into camera detached from the body .....	13
3.1.4 Pointers on the use of the 35mm camera .....	14
3.2 35mm color photography .....	14
3.3 Fluorescein photography .....	16
3.4 Photographing with optional filters .....	18
3.5 Photography using blue filter .....	19
3.6 Stereo photography .....	19
3.7 Recording patient data by ID mode .....	20
3.7.1 Setting the ID mode .....	20
3.7.2 Recording patient data (ID mode) .....	20
3.8 Power saving function .....	21
<b>4. MAINTENANCE AND CHECKING</b> .....	22
4.1 Daily care .....	22
4.2 Cleaning the objective lens .....	22
4.3 Changing the lamp .....	22
4.3.1 Changing the illumination lamp .....	22
4.3.2 Changing the xenon lamp .....	23
4.4 Changing the fuses .....	24
4.5 Schedule of expendables and accessories .....	24
<b>5. BEFORE REQUESTING SERVICE — TROUBLE SHOOTING GUIDE</b> .....	25
<b>6. SPECIFICATIONS</b> .....	28
<b>7. OPTIONAL ACCESSORIES</b> .....	29
7.1 Polaroid attachment PA-50XC .....	29
7.2 Polaroid attachment PA-50XF .....	31
7.3 1X Relay Lens Adapter .....	33
7.4 Video Relay Lens Adapter .....	35
7.5 Internal Fixation Target .....	39
7.6 Observation Tube .....	40
<b>8. EXPOSURE GUIDE FOR RETINAL CAMERA MODEL TRC-50X</b> .....	42

# 1. NOMENCLATURE AND FUNCTIONS

## 1.1 Main Body

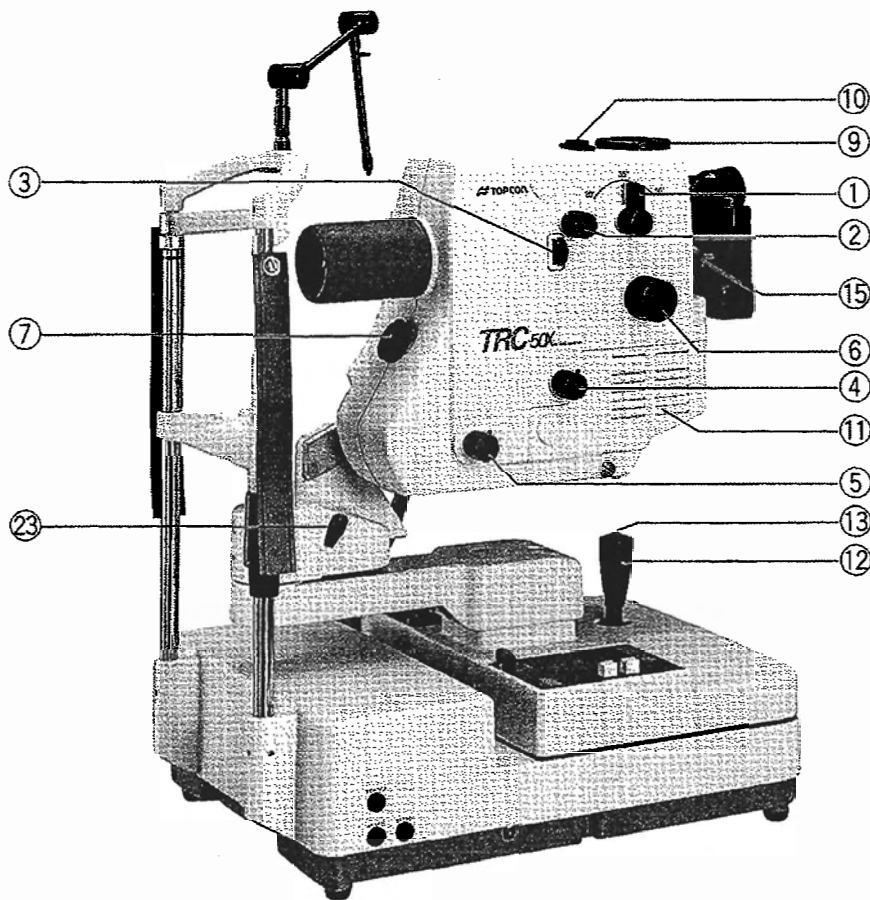

- ① **Angle changing lever**
- ② **Diopter compensation knob**  
Used to compensate the dioptric power of strong myopia and hyperopia in the patient and also used for ocular anterior photography.
- ③ **Astigmatic correction knob**  
Rotated for obtaining a uniform focus, when taking peripheral photographs.
- ④ **Filter switching knob**  
Changed for different kinds of photography.  
N : For normal 35mm color photography, fluorescein angiography and Polaroid color angiography.  
G : For red-free photography.  
F1 & F2 : For using filters required for specialized retinal photography.  
(When the Filter switching knob ④ is set to either F1 or F2, function of some instruments may be prohibited as NF switch ⑳ blinks depending on destina-
- ⑤ **Illumination diaphragm knob**  
When dilation is not sufficient, set the angle to 35° or 20° and rotate out this knob and set on S.  
In the case of Polaroid fluorescein angiography, set on FP.  
Do not use this knob when dilation is satisfactory.
- ⑥ **Focusing knob**
- ⑦ **Internal fixation target mount**  
The optional internal fixation target can be mounted.
- ⑧ **Data plate insertion slot**  
For inserting the plastic data plate on which patient's information is handwritten with a marker pen.  
For photographing information together with the retinal image and the time or frame number.

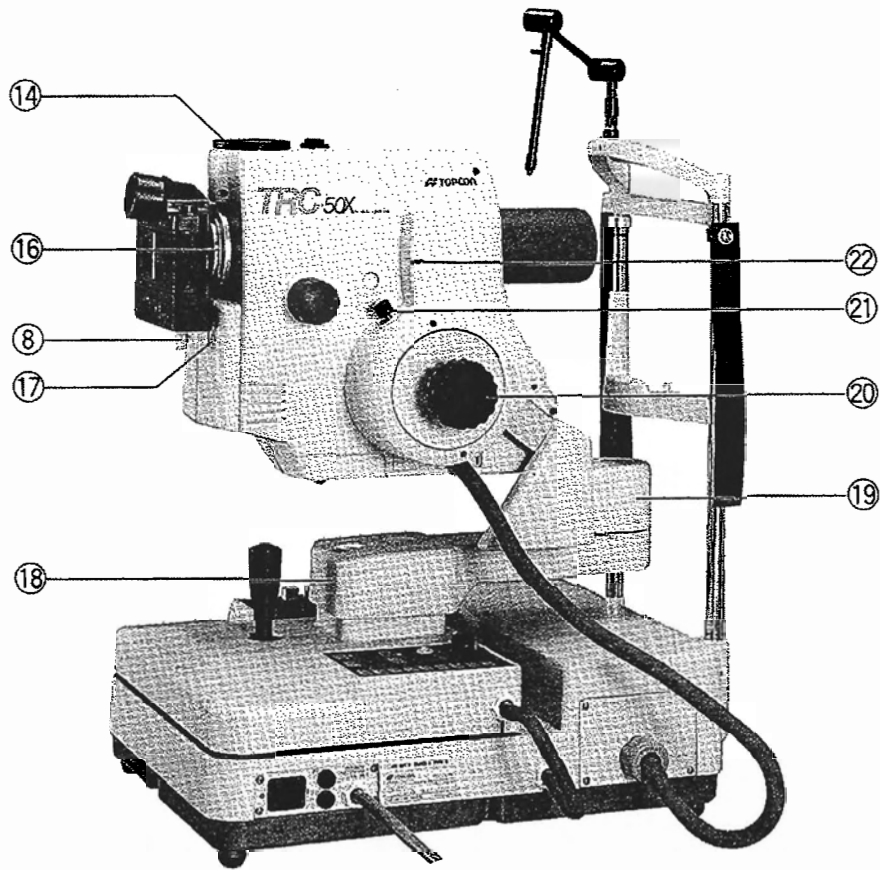

- ⑨ **Accessories mount: Polaroid attachments**  
1× relay lens adapter and video relay lens adapter can be mounted here.
- ⑩ **Output connector for accessories**  
(Polaroid attachments, 1X relay lens adapter and video relay lens adapter)
- ⑪ **Lamphouse cover**
- ⑫ **Control lever**
- ⑬ **Shutter release button**  
Xenon lamp flashes upon depressing the shutter release button.
- ⑭ **Accessory mount cap**
- ⑮ **35mm camera body locking lever**
- ⑯ **Mount for 35mm camera body**
- ⑰ **Alignment illumination point switch**  
(This function is omitted for certain destinations.)

- ⑱ **Lower arm**
- ⑲ **Upper arm**  
Swings up to 30° to the right and left.
- ⑳ **Tilting handle**  
Swings up to 15° upward and 10° downward.
- ㉑ **Tilt brake knob**  
Turned to make tilt free and locked, and for adjusting the brake force.
- ㉒ **Horizontal index window**  
Indicates red when the main body is level (tilt 0°).
- ㉓ **Swing arm locking lever**

## 1.2 Control Unit

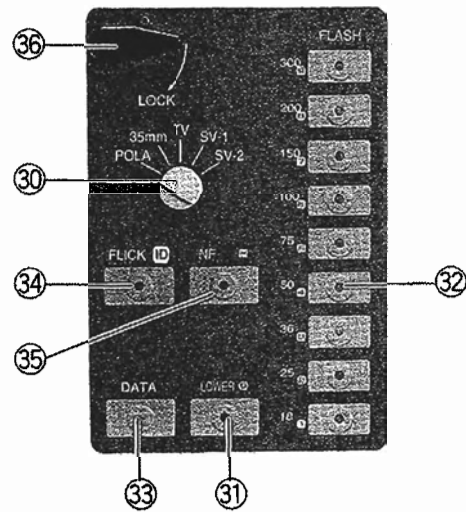
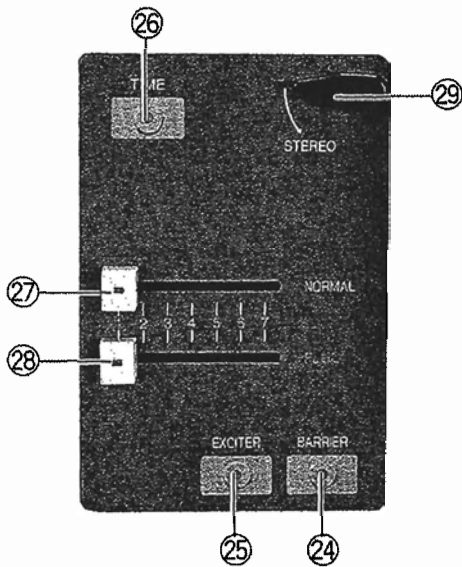

- ②④ **Fluorescein (barrier) filter switch**  
Press the switch to set the barrier filter. Press again to remove the barrier filter. Press one of the fluorescein filter switches and the shutter release button ⑬ to insert the remaining filter.
- ②⑤ **Fluorescein (excitation) filter switch**  
Press this switch to set the excitation filter. Press again to remove the excitation filter.
- ②⑥ **Timer switch**  
The timer starts upon pressing once and stops when pressed a second time. When the counter is not used as a timer, the number of frames exposed is photographed in one frame increments each time the shutter is released. Under the ID mode, the counter function is not available.
- ②⑦ **Normal color photography knob**  
(Normal color photography illumination setting)
- ②⑧ **Fluorescein angiography knob**  
(Fluorescein illumination setting)  
Illumination adjustment for fluorescein angiography.
- ②⑨ **Stereo photo locking lever**  
Tighten the lever and stereo photography is possible by moving the base right and left.
- ③① **UPPER camera selection switch**  
Set to UPPER camera to select Polaroid

- photography, photography by 1X relay lens adapter and photography by video relay lens adapter.
- ③① **UPPER/LOWER selector switch**  
When UPPER is selected, the photography mode selected by the UPPER camera switch ③① is activated. When POWER SAVE operates, push the switch to reset. Under the ID mode, it works as the "0" key for data input.
- ③② **Flash intensity switch**  
Photography light intensity can be selected in 9 steps. Under the ID mode, the switches work as the numeral keys 1 to 9 for data input.
- ③③ **DATA switch**  
To photograph the patient physical record, push the switch and let the xenon lamp flash.
- ③④ **FLICK (ID) switch**  
Switches the fixation target between lighting and flash. Under the ID mode, the switch sets the DATA input mode, and fixes the input data (numerals) (cancels the DATA input mode).
- ③⑤ **Non-flash switch**  
Used to make the xenon lamp off (when loading the film). Under the ID mode, the switch works as the "-" key for data input.
- ③⑥ **Base fixing knob**  
Rotate to lock and release base.

## 1.3 35mm Motor Driven Camera Body

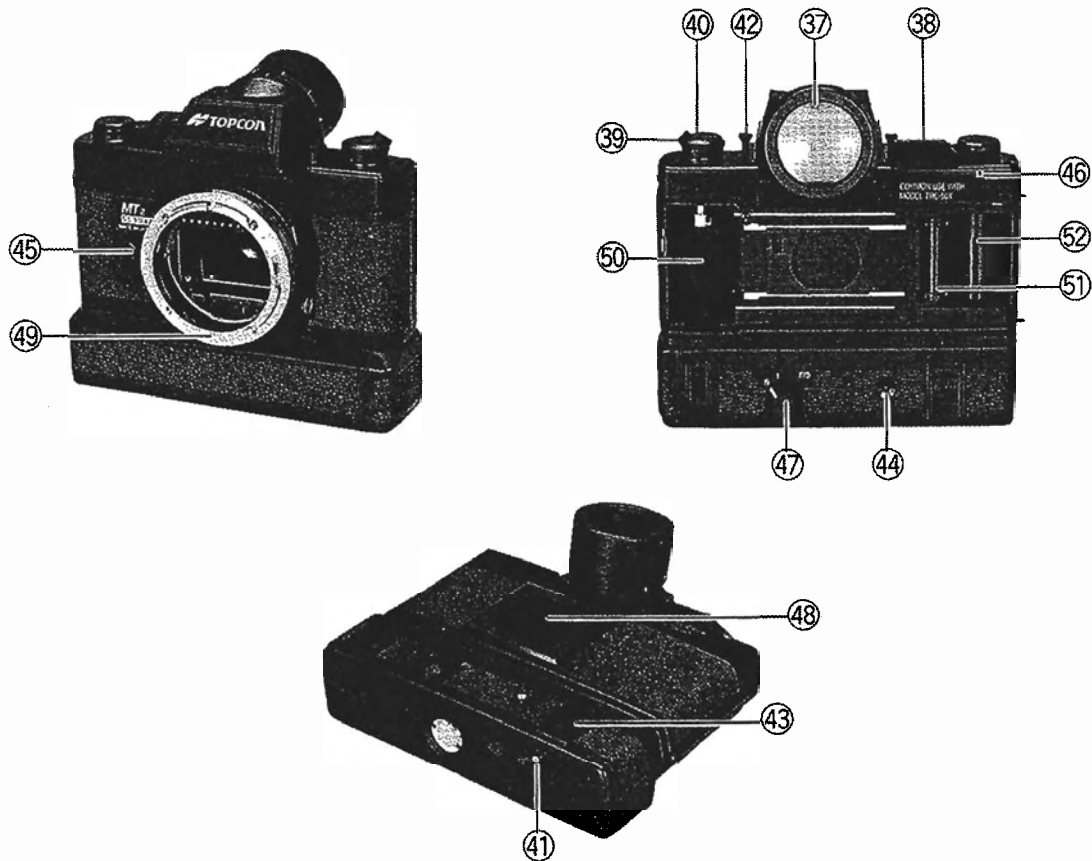

- 37 Eyepiece**  
Adjust to the user's refractive error by rotating eyepiece.
- 38 Film winding lever**
- 39 Rewind crank**
- 40 Back cover locking knob**  
Back cover is opened by pulling this knob up fully.
- 41 Rewind button (camera)**
- 42 Finder catch**
- 43 Motor-drive switch**  
Always leave at the ON position for photography.
- 44 Warning lamp**  
When the lamp lights on, turn the motor-drive switch **43** OFF. Turn the switch back to the ON position and confirm that the motor-drive is operating.
- 45 Shutter release lever**  
The lever is used in order to release the shutter when manual film winding is undertaken with the motor-drive switch **43** set to OFF.
- 46 Film counter**  
Shows the number of frames exposed. Automatically illuminated upon loading film in the camera.
- 47 Photography speed selector**  
Used for setting the firing speed, as follows.  
S: One frame for each shutter release.  
1: Hold joystick button down for 1 frame/sec.
- 48 Memorandum holder**  
Holder for the end flap of the empty box of the loaded film.
- 49 Camera mount**
- 50 Film chamber**
- 51 Sprocket**
- 52 Multi-slots on the take-up spool**

## 1.4 Power Supply Unit

- ⑤③ Power switch
- ⑤④ Body connected cord
- ⑤⑤ Power cord
- ⑤⑥ Voltage selector
- ⑤⑦ Primary fuse holder
- ⑤⑧ Secondary fuse holder
- ⑤⑨ Chinrest adjusting knob
- ⑥⑩ External fixation target

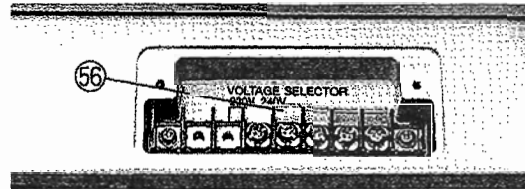
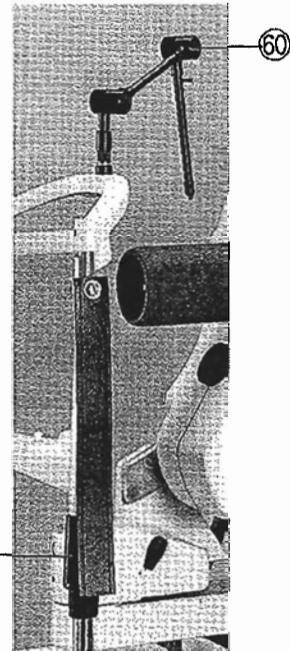
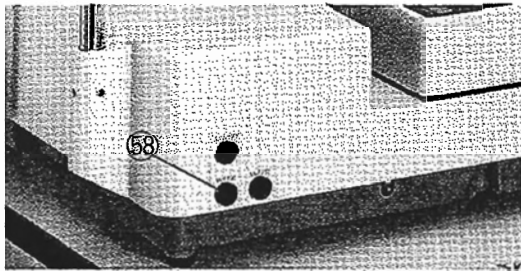
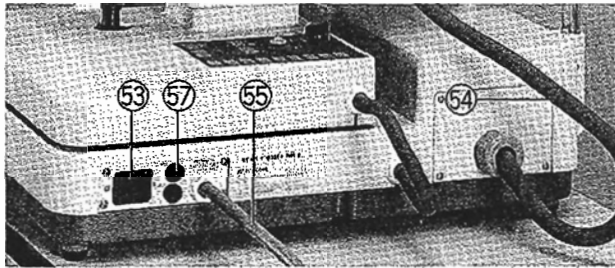

## 1.5 Accessories

	Quantity
• Accessories case	1
• Dust cover	1
• Chinrest paper	1
• Chinrest paper fastening pins	2
• Fuses	6
• Data plate	5
• Hexagonal wrench	1
• Phillips screwdriver	1

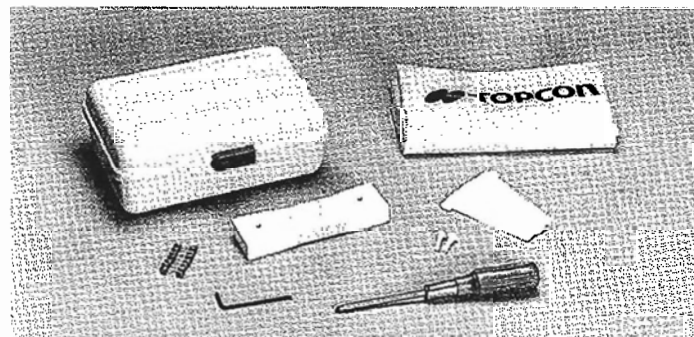



## 2. ASSEMBLY

All components of TRC-50X are included in two carton boxes.

### 2.1 Components

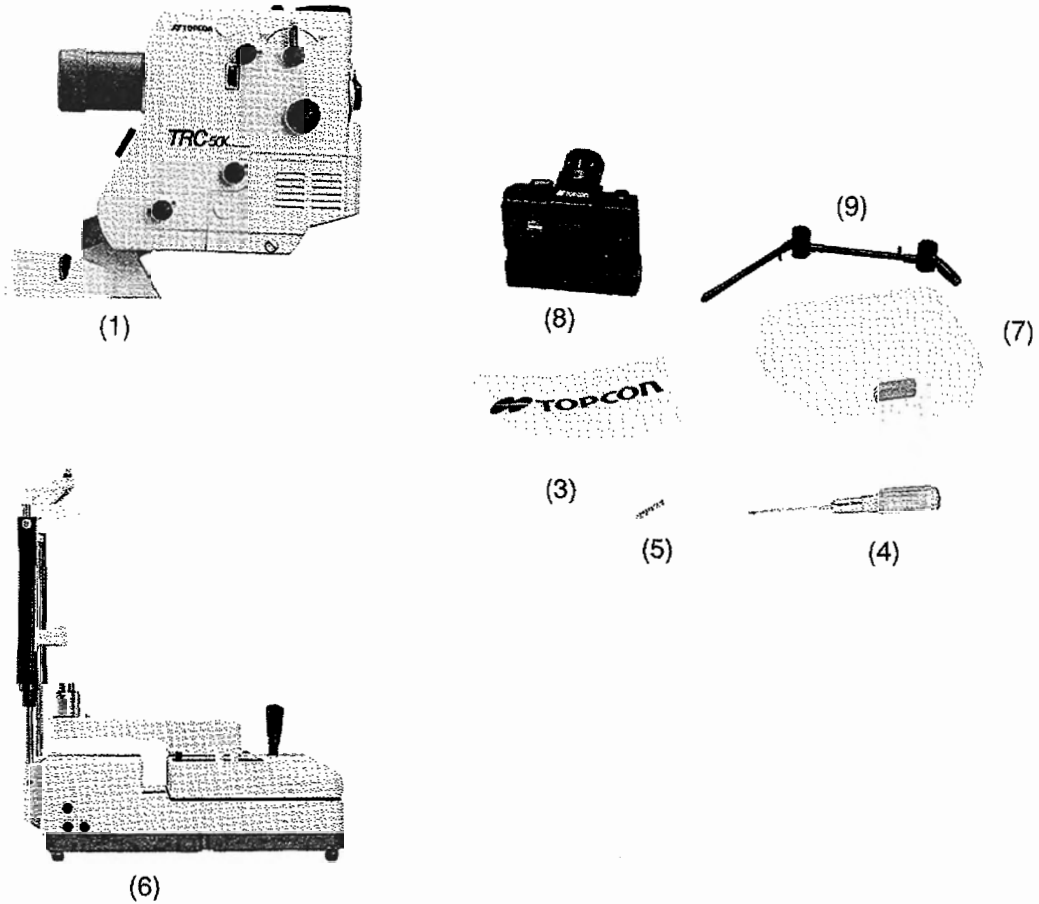

Description	Quantity	Casing
(1) Main body	1	Main body unit
(2) Instruction Manual	1	Main body unit
(3) Dust cover	1	Main body unit
(4) Phillips screwdriver	1	Main body unit
(5) Connector cover set screw	5	Main body unit
(6) Power supply unit	1	Power supply unit
(7) Accessories case	1	Power supply unit
(8) 35mm motor driven camera	1	Power supply unit
(9) Fixation target	1	Power supply unit

## 2.2 Assembling procedure

When handling the main body and power supply unit, hold them firmly with thorough care. If dropped or if your hands and fingers are caught between components, they may cause injury.

\* For component names, see pages 1-5 of the Instruction Manual.

- (1) Remove the power supply unit from its storage box and place on a table.

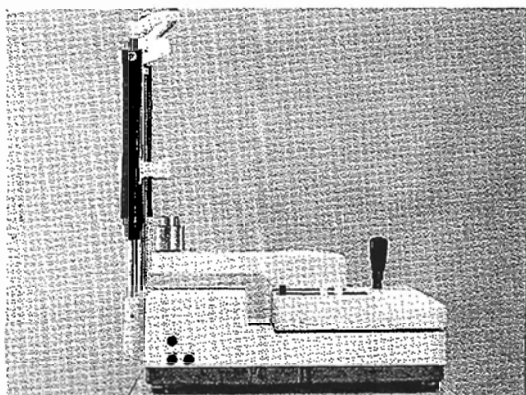

- (2) Set the second arm (upper arm ⑱) fixing knob to the (dot) mark position.

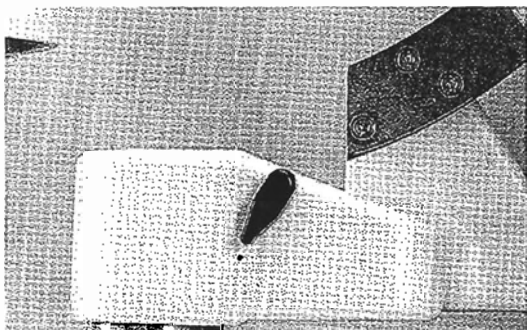

- (3) Insert the second arm (upper arm ⑱) over the shaft protruding from the first arm (lower arm ⑱). Fasten the screw at the tip of the second arm ⑱, using the attached hexagonal wrench.

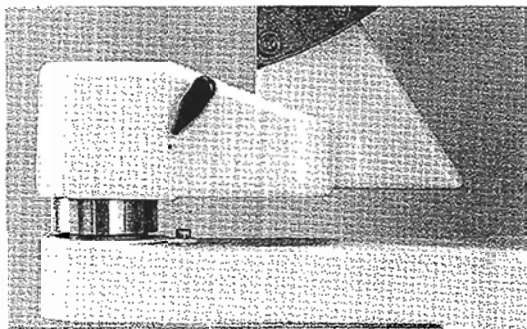

- (4) From the punched portion provided on side face of the power supply unit, take out the connector (socket) by about 10 cm.
- (5) Connect the connector (socket) to the connector (plug) of the main body.

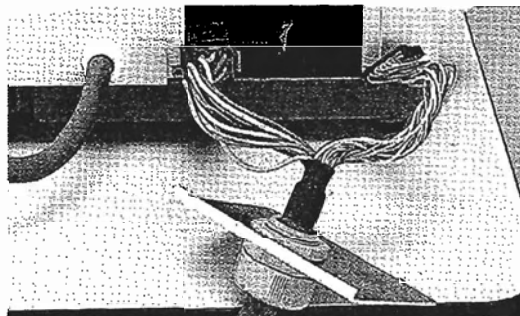

- (6) Also, connect another connector (plug) to the connector (socket) provided on the substrate.

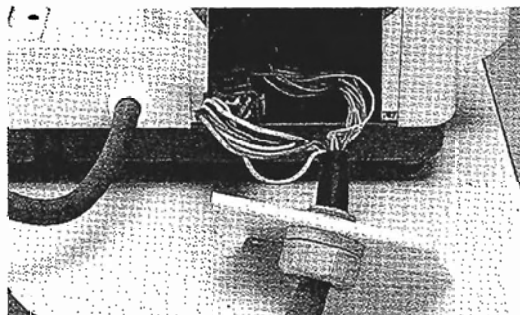

- (7) House the cord back into position without bending it, and fit the connector cover onto the side of the power supply unit. Fix the connector cover with screws.

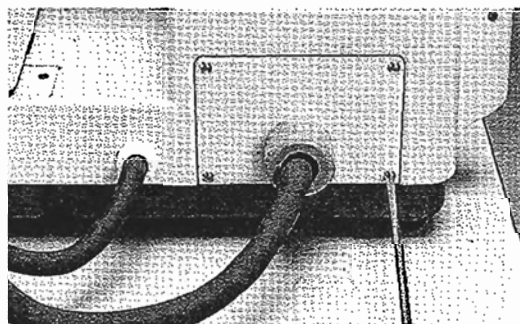

- (8) Connect the connectors of the external fixation target to the chinrest.

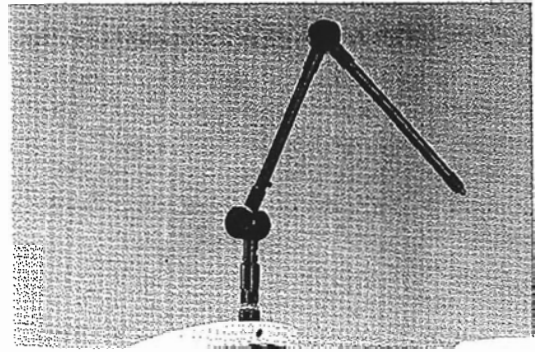

## 2.3 Checking the primary voltage

Give a check to voltage before assembling the instrument. Make sure that the voltage coincides with the voltage as set by power supply voltage selector. If it does not, unscrew voltage selector cover and remove the screw securing voltage selector wire so as to insert the wire where service voltage for use is marked. After replacing and tightening the screw, replace voltage selector cover to the original position.

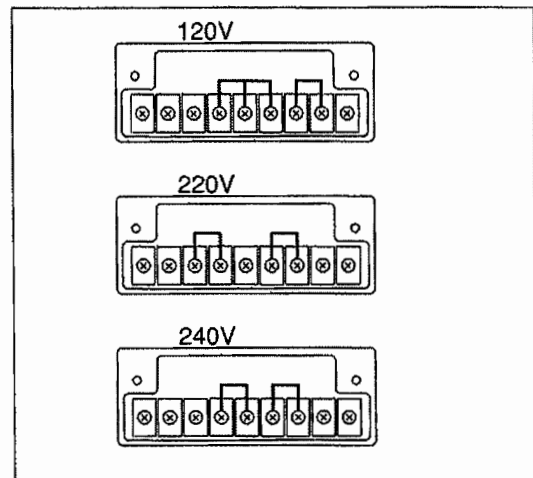

## 2.4 Checking the power supply outlet

As the instrument utilizes a 3 pin plug, check that it matches with the power outlet. If the

plug does not match, consult an electrician and make provisions for grounding.

## 2.5 Checking power frequency

First of all turn the power switch 53 OFF and disconnect the power cord 55 from the outlet. Then, check that the NO.5 switch on the switch panel (Fig. 2) at the bottom of instrument (Fig. 1) is set to the position corresponding to the frequency of your area: the switch NO.5 is set to upper position (where the digit 1 to 5 is printed is upward) for 60Hz frequency and to lower position for 50Hz. Check the frequency of your available power and verify that the switch is at the correct position.

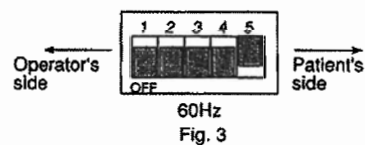
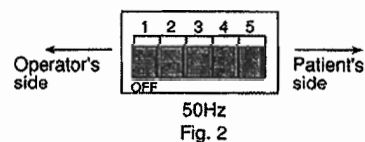
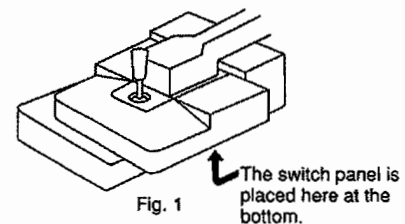

## 2.6 Checking tilt balance

After fitting optional accessories, loosen the tilt brake knob ① and check balance by tilting the body. At the factory, it is balanced with the Polaroid photography unit. If balance is to be readjusted after fitting optional accessories, see next page.

### How to adjust tilt balance

Tilt balance is adjusted with the attached Polaroid photography unit. However, balance is broken when the TV unit is mounted or the Polaroid photography unit is dismounted. In this case, readjust balance.

- (1) Tighten the tilt brake knob ① and lock tilt, and mount optional accessories.
  - The tilt brake knob ① is free when loosened. When tightened, brake is applied until the lock status is reached.
  - The tilt brake knob ① operates about 2.5 turns from the free status to the full-lock status. Do not force to turn the knob excessively.

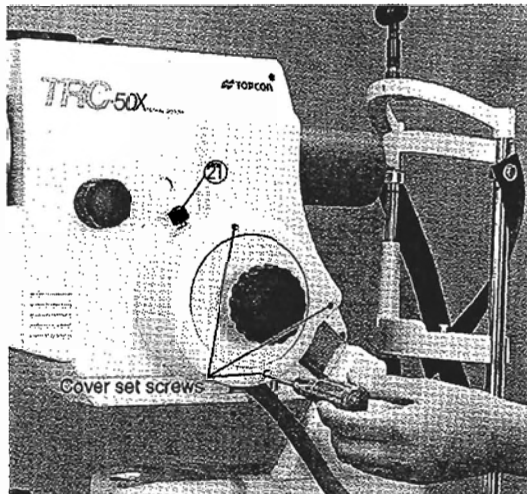

- (2) Loosen the tilt brake knob ① till the free status and check balance.
- (3) Remove three screws and remove the tilt cover.
- (4) Loosen the safety stopper screw (a)
  - Loosen the safety stopper screw about 4 turns (not necessary to remove).

- (5) (If the body is heavy and stays low)  
Insert the screwdriver into a hole at the bottom part of the tilting unit, turn it clockwise a little, and while holding the screwdriver at the position, hold the stopper (b) and pull it in the arrow direction.
  - If the body is light and stays up, insert the screwdriver into a hole at the top part of the tilting unit and turn it counterclockwise, and then do the same as above.

(Caution) When pulling stopper (b), be sure to insert the screw driver thoroughly into the hole of the tilting unit and hold it tight. Be careful, for in case the screw driver is not inserted enough and comes off, the spring inside may be loosened at once and the body will fall suddenly.

- (6) Release the screwdriver which was held in position in (5) above, and turn it to wind up the spring until the stopper (b) drops.
  - After making sure that the stopper (b) is surely off, pull out the screwdriver.

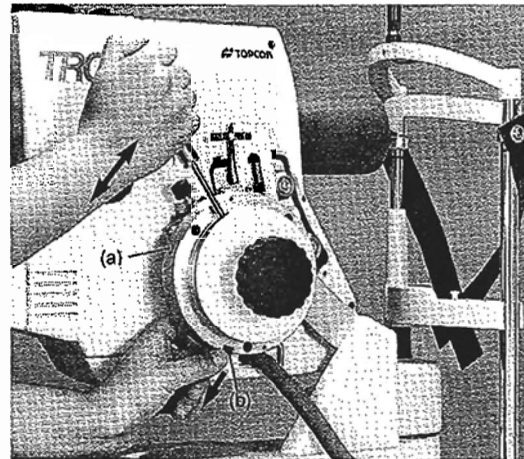

- (7) Repeat operations (5) and (6) (to wind up the spring) until the body stays level.
  - Conduct tilting operation and check balance.
- (8) Tighten the safety stopper screw (a) and set the cover.

### 3. PHOTOGRAPHY

#### 3.1 Preparations

##### 3.1.1 General preparations

- (1) Dilate the patient's pupil with mydriatic.  
Confirm whether the patient's pupil are dilated more than  $\phi 6\text{mm}$ .  
If dilation is inadequate:  
When the pupils are only dilated between  $\phi 4.5\text{mm}$  to  $\phi 5\text{mm}$ , set the illumination diaphragm knob ⑤ to the S position. Also, photograph at a picture angle of  $35^\circ$ , or  $20^\circ$ . When photographed at the  $50^\circ$  angle, it will not be completely possible to eliminate flare.

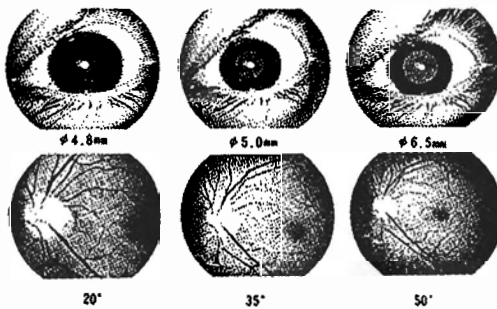

- \* Do not use the illumination diaphragm knob ⑤ other than when dilation of the pupil is inadequate.

- (2) Mount 35mm camera onto the main body.  
Mounting and releasing of 35mm camera:
- Lock base fixing knob ⑩.
  - Turn the 35mm camera body locking lever ⑪ of the main body.
  - Align the slot of the camera mount ⑫ with the marking point of the mount for the 35mm camera body ⑬. Next, press the 35mm camera against the optical head.

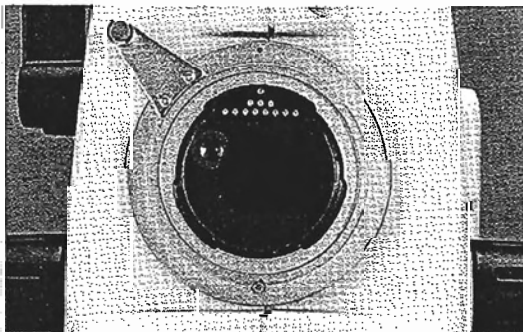

- d) Turn the 35mm camera body locking lever ⑪ in the counter-clockwise direction and fix it.

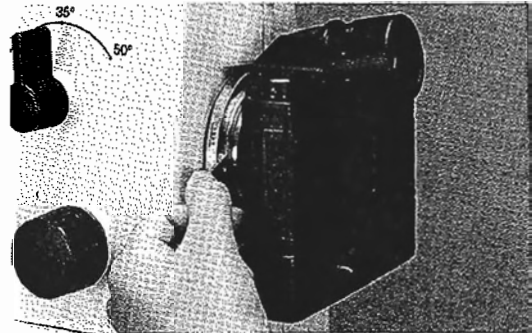

- e) To detach the camera body, hold the 35mm camera body in the right hand, and turn the lever ⑪ clockwise to the position of the stopper with the left hand. Then, pull out the 35mm camera body.

##### (3) Film loading

See 3.1.2 "Film Loading" on page 12.

##### (4) Setting the firing speed

- a) Taking single frame exposures  
Set the photography speed selector ⑭ to "S" and depress the shutter release button ⑮. A single frame will be exposed each time the shutter release button is pressed, with the film advanced automatically to the next frame.

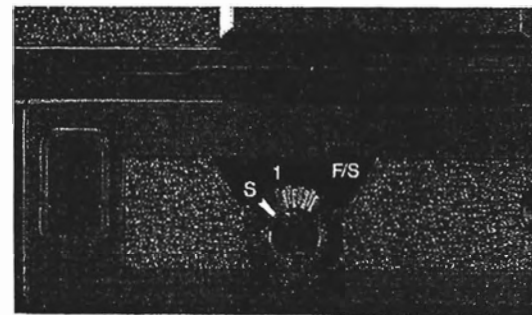

- b) Taking continuous photographs  
Set the photography speed selector ⑭ to "1", as the case may be, and hold down the shutter release button. Photographs will be taken continuously at firing speeds of one frame per second,

depending on the setting of the timer knob.

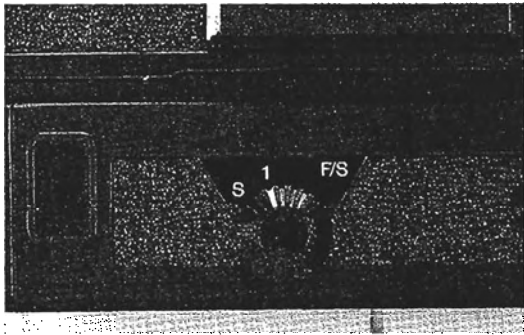

(5) Adjustment of the eyepiece

- a) The eyepiece ⑦ must always be adjusted for the user's eyesight, otherwise the instrument will not be focused properly on the retinal surface. Place a white sheet of paper in front of the objective lens for this purpose. If the adjustment is not accurate, improperly focused photographs may result.

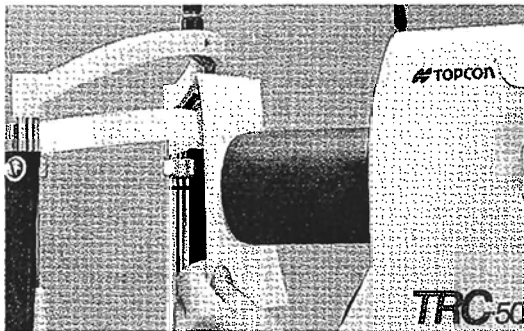

- b) First, unfocus the eyepiece by rotating its adjustment ring in the counter-clockwise direction, which will make the cross-hairs appear completely blurred. Next, rotate the adjustment ring slowly in the clockwise direction while checking the cross-hair image in the field of view. Stop when the image is sharply focused.

Finder field-of-view

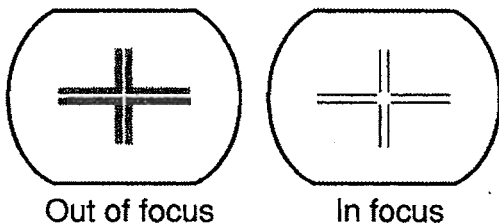

- (6) Seat the patient properly  
Have the patient, with completely dilated pupil, sit down in front of the instrument. Adjust the height of the Instrument Table in order to rest the chin properly on the chinrest and the forehead against the head strap.  
The AIT up-down switch is very convenient for this purpose while the height of the chinrest can be adjusted by rotating the chinrest adjusting knob.

- (7) Set the filter switching knob ④ to "N". "N" is suitable for normal 35mm color photography and fluorescein photography, while "G" is used when contrast of blood vessels is to be emphasized. For F1, F2 settings see section 3-4 on inserting optional filters on page 18.

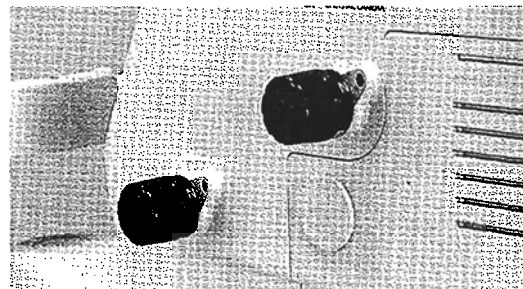

- (8) Set the angle changing lever ① to the required angle of coverage. The angle changing lever must be properly positioned at the 50°, or 35° or 20° settings. Set the lever at the click-stops, as intermediate positioning will result in image distortion and a ghost image in the center of the picture.  
The three angles of coverage, (50°, 35° and 20°) retain the same magnifications as with the former TOPCON Variable Angle Retinal Cameras of the TRC-50V/W series. This means that retinal photographs can easily be compared with those taken previously.

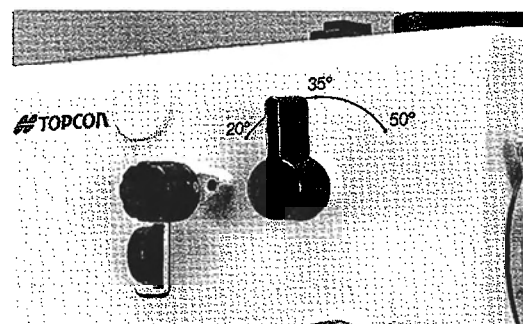

(9) Patient's fixation

In order to have the patient fixate on the external fixation target ⑥ properly, coincide the patient's line of sight to the fixation target by directing the light beam from the fixation target into the patient's pupil. The fixation target is easily changed from steady illumination to flickering illumination by means of a simple switching action. The flash device is very effective for myopic patients as well as the more difficult fixators.

that the patient feels comfortable and free from xenon lamp flashing.



3.1.2 Loading 35mm camera with film

When loading film into camera mounted onto the body

- (1) Turn motor drive switch ④ on. At this time, never attempt to move shutter release lever ⑤. If the lever is used with camera mounted on instrument body, rapid advance will be caused, and trouble may result.

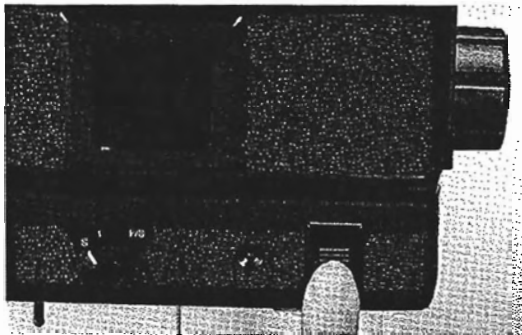

- (4) Pull back-cover locking knob ④ fully upward. 35mm camera back cover will be opened.

- (5) Put film in cartridge chamber ⑤ while keeping the back-cover open with the back-cover locking knob ④ pulled up.

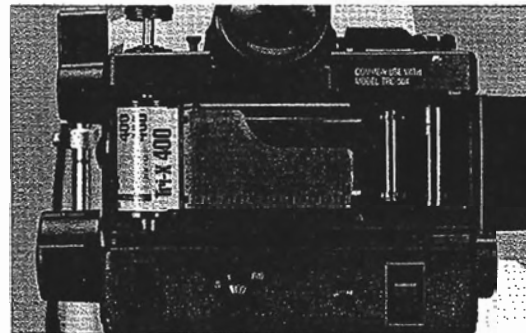

- (2) Press UPPER/LOWER selector ③ "LOWER" on the control unit. Power will be supplied to motor drive.

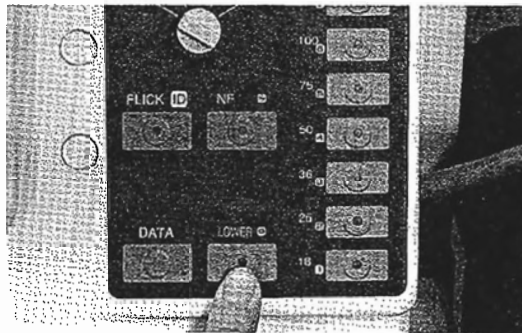

- (6) Push down back-cover locking knob ④ while turning it so that the convex of the film cartridge may be engaged with back-cover locking knob groove.

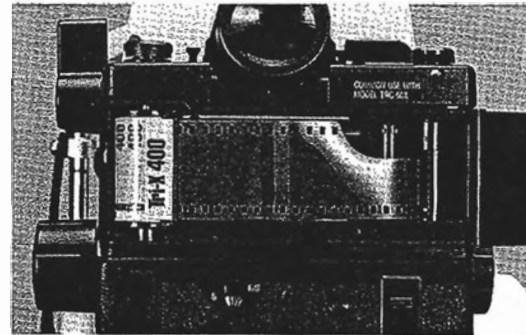

- (3) Non-flash switch Pressing non-flash switch ⑤ will keep the unit from flashing by mistake during the following (4) - (11) procedures so

- (7) Pull out the lead of film and insert it correctly in the spool groove (52). Do not touch the aperture mask on the film rail. It is easily damaged.

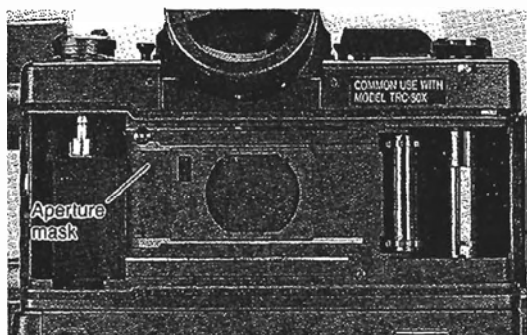

- (8) Engage film perforation with sprocket (51) teeth and check it before releasing shutter release button (13). Set photography speed selector (47) at "S" and release shutter release button (13). Do not advance film manually. If manually advancing is required, be sure to turn motor drive switch (43) off.

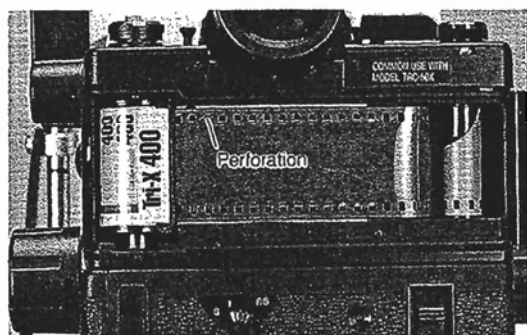

- \* If motor drives does not work after manual advance, turn motor drive switch (43) off once, then switch on again.

- (9) Check to see that film has not slackened and cartridge is in place. If cartridge is not in place, turn rewind crank (39) clockwise till it stops, and correct slackened film in cartridge.

- (10) Make sure that film is properly advanced before closing back-cover. Press back-cover gently till it is locked.

- \* If rewind crank (39) turns counter-clockwise when each time film is advanced, film is correctly advanced.

When film is not advanced, repeat film loading procedure as perforations may not have engaged with sprocket teeth.

- \* When film is loaded, film counter (46) will be illuminated. This is useful to check

the number of remaining frames of film.

- (11) Release the shutter till film counter (46) shows the first frame.

The film counter (46) gives numbers of exposed frames in the order of S, 1, 2, ... 36 and E.

- (12) Start photography when film counter (46) shows the first frame.

- (13) Alarm lamp lights when film frames is ended. Turn motor drive switch (43) off. Checking film frame number. When film counter (46) shows the last frame of film (36 in case of 36-frame film, and 24 in case of 24-frame film), film advancing will stop automatically, preventing further photography. When film is removed, the film counter (46) illumination will go out.

- (14) Press rewind button (41) by finger tip.

- (15) Raise rewind crank (39) and turn it clockwise till you hear film come out of sprocket (51).

- (16) Pull up back-cover locking knob (40). When back-cover is opened, film counter (46) at the same time returns to S.

- (17) Pull out the exposed film.

### 3.1.3 Loading 35mm camera with film

When loading film into camera detached from the body

- (1) Turn motor drive switch (43) off and follow steps as in (4) to (6) of 3.1.2 "Loading 35mm camera with film".

- (2) Engage film perforations with sprocket (51) teeth, and check it before advancing film. When operating film winding lever (38), be sure to advance a frame fully until the lever stops. Then follow steps (8) and (9) in 3.1.2. Film counter (46) will not light even if film is loaded.

- (3) Repeat winding the film and releasing the shutter release lever (45) until film counter (46) shows the first frame.



(4) Mount 35mm camera on the instrument body.

\* See General preparations 3.1.1. on P. 10.

(5) Turn motor drive switch ④③ on.

### 3.1.4 Pointers on the use of the 35mm camera

(1) Always switch off the motor drive switch ④③ when unloading the film.

(2) Wipe the contacts on the camera mount ④⑨ gently with a clean cloth, from time to time, in order to maintain good electrical connection.

(3) Do not touch the mirror surface and contacts.

(4) Clean the film chamber ⑤⑩, sprocket ⑤⑪, multi-slots on the take-up spool ⑤⑫ and film pressure plate, from time to time, in order to prevent scratches on the film.

## 3.2 35mm color photography

(1) Press the UPPER/LOWER selector ③① of the control unit to set on LOWER.

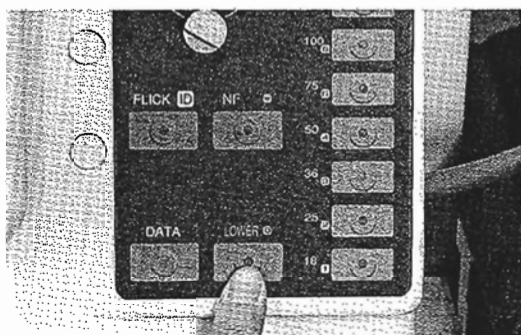

(2) Flash intensity (36WS) is set automatically.

However, when using a film other than ISO100, set flash intensity by the flash intensity switch ③② according to "8. Exposure Guide for Retinal Camera Model TRC-50X" on p.42.

(3) Data photography for the patient.

(a) How to photograph the patient's data on the data plate.

Write down the required information on the data plate and insert it in the data plate insertion slot ③③.

It will be photographed together with the retinal image.

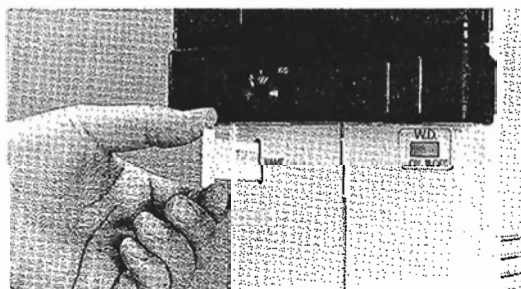

\* When setting the ID mode, see "3.7 Recording patient data by ID mode" on p. 20.

(b) When recording together with ocular anterior photography.

i) Write data within  $\varnothing 30\text{mm}$  on a patient physical record, set the diopter compensation knob ② on either (+) or (A), and focus.

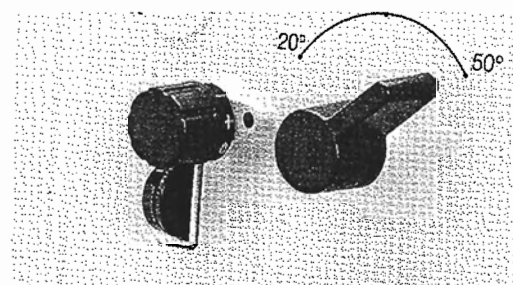

ii) By pressing the data switch ③③ of control unit, the xenon lamp will flash and the data is recorded.

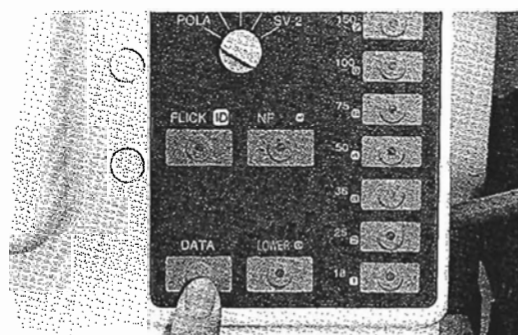

(4) Alignment of the light beam onto the patient's pupil.  
Finely adjust the optical head longitudinally for evenly illuminating the retina.

First look at the patient's pupil from the side of the instrument. To coincide the light beam properly to the patient's pupil, move the optical head into a position 50mm in front of the patient's eye, with the control lever positioned straight. Then adjust the control lever to the right or left and rotate it to move the optical head up or down, until the light beam is coincident with the patient's pupil. Then, finely adjust the control lever to focus the ring image on the cornea coincidentally with the patient's pupil.

Ring slit images on cornea

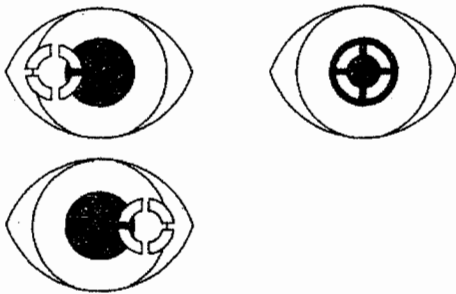

Images observed by viewfinder

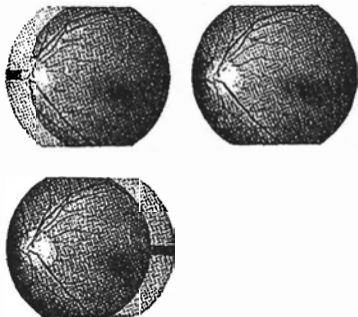

Images filmed by camera

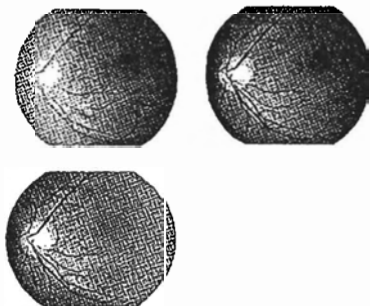

- (5) When focussing the retinal image with the focusing knob ⑥, it should be remembered that not only the retinal image but the cross-hairs must also be observed sharply and distinctly in the field at the same time. Otherwise, the retina will not be focused properly on the film plane.

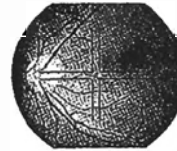

- When the alignment illumination points are used:

Move the optical head into a position about 50mm in front of the patient's eye, with the control lever ⑫ positioned straight. Then adjust the control lever ⑫ to the right or left and rotate it to move the optical head up or down until the light beam becomes coaxial with the patient's pupil, when alignment illumination points appear on both sides in the finder. Make these points the smallest.

If the patient moves the eyes or when photographing the periphery, sometimes the alignment illumination points disappear.

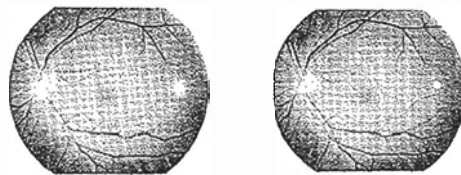

- (6) Photographing retinal peripheries  
Move the external fixation target ⑥⑩ and have the patient fixate with the eye that is not being photographed, without moving the eye that is being photographed. It will be possible to photograph the peripheries and other sections of the retina, by tilting and/or swinging the optical head. There will be instances when the focus is not uniform, when photographing the peripheries. In such cases, rotate the astigmatic correction knob ③ and obtain an uniform focus.

- The tilt brake knob ⑳ is free when loosened. When tightened, brake is applied until the lock status is reached.
- The tilt brake knob ㉑ operates about 2.5 turns from the free status to the full-lock status. Do not force to turn the knob excessively.

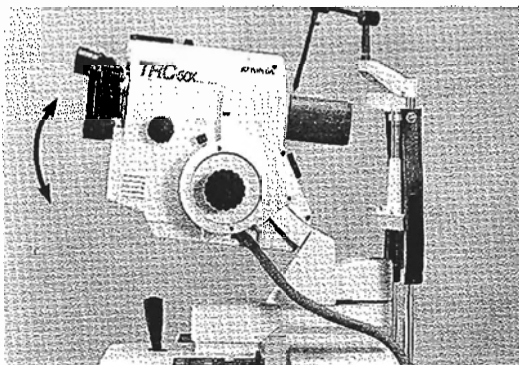

- Turn the tilt brake knob ㉑ and get a condition suited for operation.

- (7) When changing the angle of coverage
  - (a) It will not be necessary to refocus when changing the angle of coverage from 20° to either 35° or 50°, if the retinal image has already been properly focused at the 20° angle of coverage.
  - (b) Flare will not occur when the angle of coverage is changed from 50° to either 35° or 20°, if the light beam has been properly coincided to the patient's pupil at the 50° angle of coverage.
- (8) Depress the shutter release button ㉓.

### 3.3 Fluorescein photography

Fundamentally, make the same adjustments as noted for color retinal photography, and focus the retinal image properly. The only difference is the insertion of the barrier filter ㉔ and excitation filter ㉕ into the optical path and the intravenous injection of fluorescein to the patient.

- (1) Load the 35mm camera with ISO (ASA) 400 black and white film.
- (2) Prepare the patient data to be included in photography.  
Operation Points:  
Write data within a  $\varnothing 30\text{mm}$  area on the patient physical record, set the diopter compensation knob ㉒ to (+) or (A) and focus, set the exciter filter by pressing the EXCITER switch ㉕, and then press the DATA switch ㉖.  
\* When setting the ID mode, see "3.7.2 Recording patient data (ID mode)" on P. 20
- (3) Adjust the fluorescein angiography knob ㉗ to the required illumination, which can be preset freely with its exclusive knob. The illumination is automatically changed to the preset intensity, when the excitation filter ㉕ is pushed in. However, if it is preset at the maximum intensity, it will usually be too bright for the patient, with the result that the patient may look away.

Therefore, it is recommended that the knob normally be set to "4" or "5".

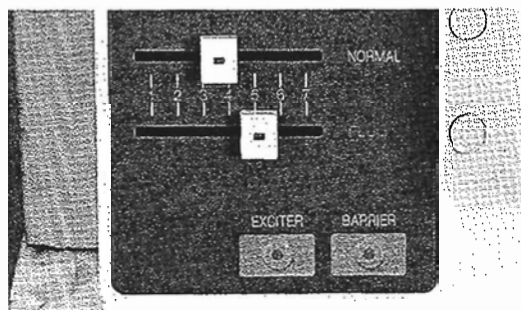

If alignment illumination points are not necessary, press the alignment illumination point switch ㉙ to put them off.

- (4) Preparations for photography  
Make the same adjustments, as noted for color retinal photography, and focus the retinal image properly.
- (5) Then, prepare the intravenous injection, which should be injected quickly for the best effect.  
If too much time is taken in giving the intravenous injection, the fluorescein will be diffused in the blood vessels and a good photograph will not be possible.

- (6) Depress the timer switch ⑳ at the same time as an intravenous injection of fluorescein is given to the patient. When the timer starts, it will keep every second up to 20 seconds. Also, the timer switch will light simultaneously every second until the timer goes OFF. In this case, note that if the data plate is inserted into the data plate slot, the timer will not be photographed.

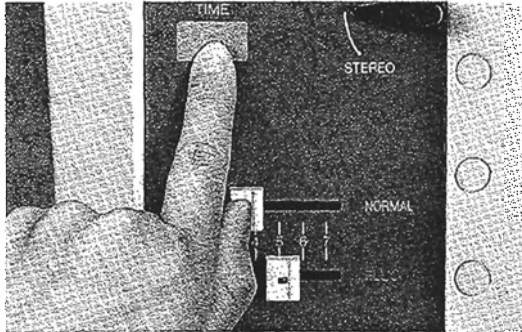

- (7) Press the fluorescein filter switches ㉔ and ㉕. If only the fluorescein (excitation) filter switch ㉕ is pressed, the excitation filter is set, and with each press of the shutter release button ⑬, the barrier filter is withdrawn and inserted into the optical path.

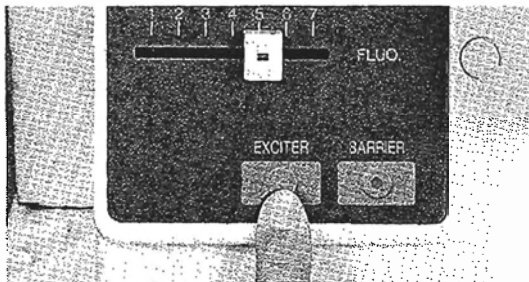

When the EXCITER switch ㉕ is pressed, flash intensity (200WS) is also set automatically.

- (8) Depress the shutter release button upon appearance of fluorescence on the retina. The firing speed by the timer switch ㉕ should be set, as required, since there is a choice of single frame exposure or continuous shooting in the motor drive action, one frame per second.  
S : Single-frame exposure per second  
1: Continuous photography of 1 frame per second

- (9) The number of frames should be divided suitably for use in fluorescein angiography since it is normal to divide photography into three stages, for covering the beginning, the middle and the ending stages of the fluorescein diffusion. The film counter ㉖ should be checked for this purpose, since it is automatically illuminated, upon loading film, and, therefore, makes it possible to easily check film loading and exposed frames.

- (10) Develop the film.  
Development of the film, in the case of fluorescein retinal photography, should differ according to conditions and, therefore, the film should be developed under inspection.

The following is a guide for developing films under average conditions:

- a) Film:  
Kodak Tri-X Pan [ ISO (ASA) 400 ]
- b) Developer : D 76
- c) Development:  
Tank development with developer temperature 22°C and 13 to 15 minutes of development.
- d) Fixing time: 10 to 20 minutes
- e) Washing time: More than 30 minutes.

### 3.4 Photography with optional filters

There are two blank settings, or F1 and F2 on the filter turret, with frames supplied for inserting filters which may be required for obtaining special photographic effects.

Simply insert the filter in the frame and then insert the filter frame, in the following manner:

#### 1. Procedure for changing filters

- (1) Turn the power switch ⑤③ OFF, and remove the power cord ⑤⑤ from the power outlet.
- (2) Next, turn the screws of the lamphouse cover in the counter-clockwise direction with a coin and take off the cover.

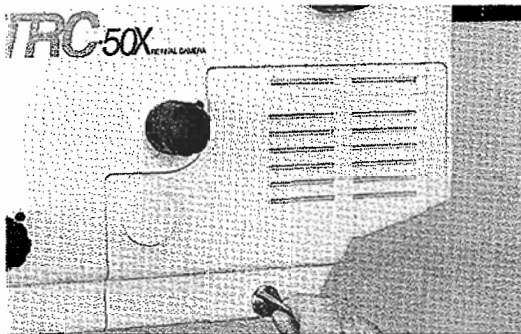

- (3) Remove the filter frame and take out the shield plate that is bonded inside the frame.

Removing the filter frame:

- (a) Rotate the filter switching knob ④ to a position where the filter frame can be seen.
- (b) Pull out the filter frame while pushing it towards the right at the same time.

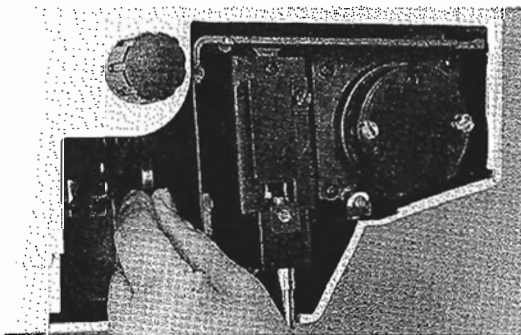

- (4) Bond a filter you like to the frame, and then insert it into the filter turret.

Inserting the filter frame:

- (a) Rotate the filter switching knob ④ to the position where filter turret guide can be seen.

- (b) Insert the filter frame along the guide and press until it clicks into place.

#### 2. Removing the prohibition of function and setting the light intensity

When the filter switching knob ④ is set to either F1 or F2 and the function of the instrument is prohibited as NF switch ⑤⑥ blinks, after setting optional filter, remove the prohibition of function, then set the light intensity.

- (1) Turn off the power switch ⑤③ and set switch No.1 provided on the right hand side of the bottom face of the base (viewed from the operator) to the numeral (ON) side. (see figure on p. 8)
- (2) Turn on the power switch ⑤③.
- (3) Press the timer switch ⑤⑥ until the buzzer continuously sounds 4 times. (about 3 seconds)
- (4) Set the filter switching knob ④ to either F1 or F2.
- (5) Press one of the flash intensity switches ⑤② that is most suitable for the filter.
- (6) Turn off the power switch ⑤③ and reset switch No. 1 provided on the right hand side of the bottom face of the base to off.
- (7) Turn on the power switch ⑤③ and make sure that the flash intensity switch ⑤② is lighted at the intensity which was set in (5).

#### 3. Procedure for photography

Photography Method:

- (1) Set the filter switching knob ④ on F1 or F2.
- (2) Select the flash intensity switch ⑤② required for the special filter.
- (3) Take photograph by the same procedure of regular 35mm color photography.

### 3.5 Photography using blue filter

For photography with the EXCITER filter, switch the interlock mode of the EXCITER filter and BARRIER filter to the non-interlock mode.

#### 1. Switching between interlock mode and non-interlock mode

- (1) Continuously press the EXCITER switch ⑳ and BARRIER switch ㉔ together, and release the switches when the buzzer sounds "Pi".

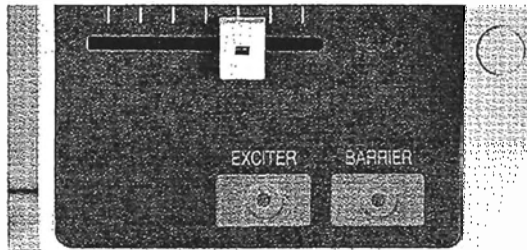

- (2) Press either the EXCITER switch ⑳ or BARRIER switch ㉔ to confirm the set mode.
  - Interlock mode  
The pressed switch turns on and the other won't.
  - Non-interlock mode  
The pressed switch turns on and the other blinks.

#### 2. Photography

- (1) Press the EXCITER switch ⑳.  
The EXCITER filter is set, the EXCITER switch ⑳ turns on, and the BARRIER switch ㉔ blinks.
- (2) Set flash intensity by the flash intensity switch ㉓.  
Flash intensity is automatically set to 200WS (for fluorescein photography) when the EXCITER switch ⑳ is pressed. Set a flash intensity suited for the film used.
- (3) Adjust illumination for observation by Fluorescein angiography knob ㉒.  
When the EXCITER filter is set, illumination for observation is adjusted by Fluorescein angiography knob ㉒.

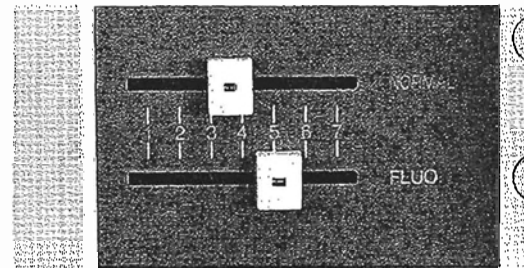

- (4) Conduct photography in the same manner as 35mm color photography.

### 3.6 Stereo photography

- (1) Stereo photography is possible with a special base parallel sliding system, for moving the base 1mm to the right and left for taking two exposures. Align the light beam to the patient's pupil and move the base until the brightness of the retinal image is uniform. Basic procedures are same as for color retinal photography. Set the photography speed selection ㉗ to "S". Namely, set the patient's pupil and the optical head to the proper position. Coincide the light beam properly to the optical axis of the patient's pupil. If not, flare will occur on one side. (see 3.2.(4) "Alignment of the light beam onto the patient's pupil", Page 14.) As flares are easy to appear at a picture angle of 50°, it is recommended to take stereo photography at a picture angle of 35° or 20°.

- (2) Tighten the stereo photo locking lever ㉙.

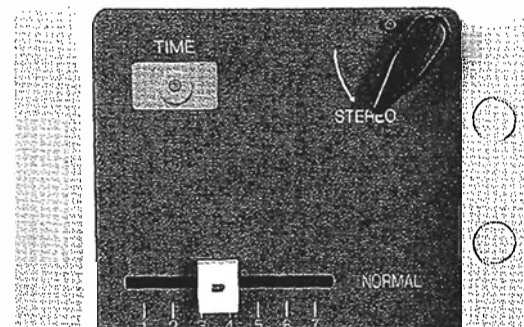

- (3) Move the base to its limit in both the right and left directions and release the shutter. If not moved fully, the stereoscopic effect will not be proper. When moving the base, always fix the arm to prevent movement.  
Furthermore, do not move the base strongly when shifting, as the movement may exceed its limits.

### 3.7 Recording patient data by ID mode

#### 3.7.1 Setting the ID mode

Turn off the power switch ③ and remove the power cord ⑤ from the receptacle, and then set the switch No.3, provided on the right hand side of the bottom face of the base (viewed from the operator), to the numeral (ON) side.

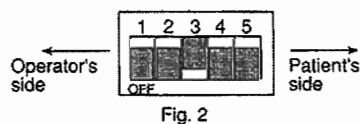
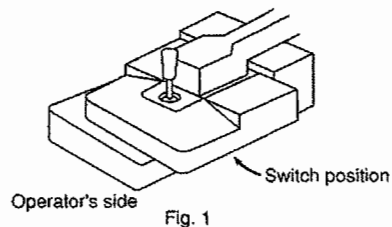

#### 3.7.2 Recording patient data (ID mode)

When the 35mm camera (UPPER, LOWER) and the UPPER TV is used, the patient data (12-digit number) is recorded simultaneously with retinal photography.

- (1) The data input mode is set by pressing the FLICK (ID) switch ③ while the buzzer continuously sounds 4 times (about 3 seconds).
  - When the data input mode is set, LEDs of the FLICK (ID) switch ③, flash intensity switch ②, UPPER/LOWER selector switch ① and non-flash switch ⑤ are turned on.

- (2) Input the patient data.

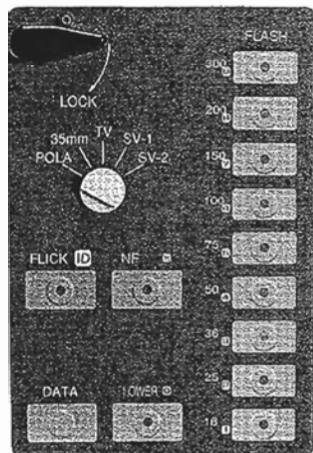

- When the data input mode is set, the flash intensity switch ② works as 1 to 9, the UPPER/LOWER selector switch ① as "0" and the non-flash switch ⑤ as "-" input key.
- A twelve-digit number is input in two stages (6 digits at the upper stage and 6 digits at the lower stage).
- The buzzer sounds "Pi" each time a figure is input. If the 13th figure is input, the buzzer sounds "Pi Pi" and rejects it.

2	5	3	6	7	8
-	7	2	0	9	3

- When the data plate is inserted, 6 digits of the upper stage are displayed, and the 7th figure is rejected with "Pi Pi" of the buzzer.

2	5	3	6	7	8
TOPCON					

- If the input data is incorrect, return to the step (1).
  - Under the ID mode, the counter function is not available.
- (3) Press and release the FLICK (ID) switch ③ (within 1 second). The buzzer sounds "Pi" and the data is registered.
    - Through the camera's finder, see if the input data is correct before registering.
    - When the data is registered, LEDs of the FLICK (ID) switch ③, flash intensity switch ②, UPPER/LOWER selector switch ① and non-flash switch ⑤ are turned off.

**Caution:** If the FLICK (ID) switch ③ is pressed continuously (about 3 seconds) the status of the step (1) is set and the data is canceled.

- (4) Focus the retina and photograph it by pressing the shutter ⑬.
  - When the data plate is inserted after registering the input data, the input data comes at the upper stage and the data plate at the lower stage on the photograph.

- (5) When inputting another data, start from the step (1).

00.15.3
235678

- (6) When the data is registered <step (3)>, the data input mode is finished.
- \* Using the timer in fluorescein photography
  - Six-digit data and the time are photographed together.

- When the TIME switch ⑳ is started, the input data is displayed at the upper stage but, when photographed, the time comes at the upper stage and the data at the lower stage.
- If the input data exceeds 6 digits, when photographed, only the 6 digits displayed at the upper stage appear at the lower stage and the time comes at the upper stage.
- When the timer is turned off, all the input data is displayed.

### 3.8 Power saving function

This system incorporates a power saving function.

- (1) The power saving function of this system automatically shuts off the power supply for the observation lamp when 30 minutes have passed without pressing the shutter release button ⑬. However, when the TV camera is used and when the TV is selected by UPPER camera selector switch ㉑, the time is extended to one hour.
- (2) When the power saving function is activated, the LED of the UPPER/LOWER selector switch ㉒ blinks. To return to the normal status, press the UPPER/LOWER selector switch ㉒.

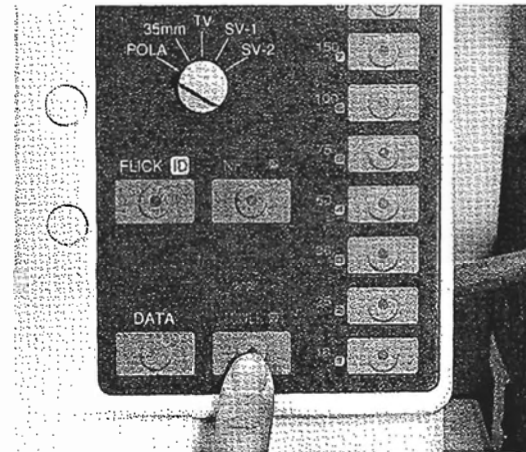



## 4. MAINTENANCE AND CHECKING

### 4.1 Daily care

- (1) Dust can affect the performance of the instrument.  
Protect the lens surface from dust, dirt and finger-prints, at all times.  
Always use the lens cap and dust cover when not in use.
- (2) To clean the plastic parts, such as outside cover, control unit, chinrest and fore-

head rest, use only a cloth moistened with a solution of neutral detergent and water to wipe off the accumulated dust. Avoid using other types of cleaners.

- (3) Turn the power switch OFF when the instrument is not in use.

### 4.2 Cleaning the objective lens

- (1) Darken the room and set the normal color photography knob ⑳ on "7" and look at the objective lens from a front oblique direction, the dirt can be seen clearly.
- (2) If dust and dirt adhere the surface of the objective lens, blow them off, taking care not to let the blower touch the lens.
- (3) If fingerprints and oil adhere:
  - (a) Blow off large dusts.
  - (b) Prepare a mixed solution containing two part of ethyl alcohol and 8 of ether.

(c) Moisten a clean gauze (washed and dried) with the mixed solution and wipe the lens surface gently in ever-widening circles from the center out. If necessary, wipe repeatedly. Do not wipe dust on the lens surface or wipe the surface roughly, as it will cause scratches on the surface.

- (3) If dirt is too difficult to remove, contact your authorized dealer or TOPCON directly.

### 4.3 Changing the lamp

[Notice]

- (1) Turn the power switch ㉓ OFF and pull out the power cord ㉔ from the power outlet.
- (2) Do not touch any lamp immediately after switching off, because the lamp will be very hot.
- (3) Do not touch a lamp with bare fingers because the surface of the lamp will become dirty with finger-prints, etc. and these stains will lead to cloudiness of the lamp.
- (4) The lamp is fragile to shock, therefore handle with extreme care.

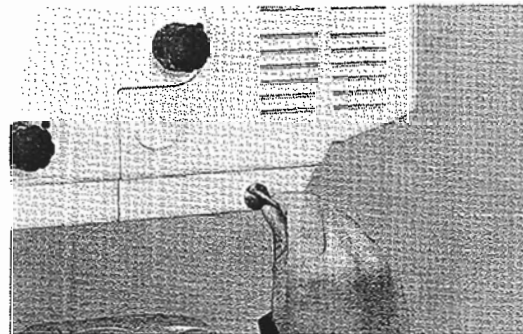

- (3) Unscrew two fixing screws of the illumination lamp and pull out the illumination lamp unit.

#### 4.3.1 Changing the illumination lamp

- (1) Check that the illumination on the control unit has been turned off.
- (2) Remove the lamphouse cover ㉑ by unscrewing the fixing screw with a coin in a counter-clockwise direction.



- (4) Insert the new illumination lamp straight in and tighten securely with the fixing screws of the illumination lamp.
- (5) Reattach the lamphouse cover ⑪. After inserting the upper protruding portion, tighten the fixing screw in a clockwise direction with a coin.

**4.3.2 Changing the xenon lamp**

- (1) After switching off the power switch ⑤③ of the power supply unit, disconnect the power cord ⑤⑤. Wait about 5 minutes for electric discharge. Loosen screws of the lamphouse cover ⑪ in the counter-clockwise direction with a coin and take off the cover.

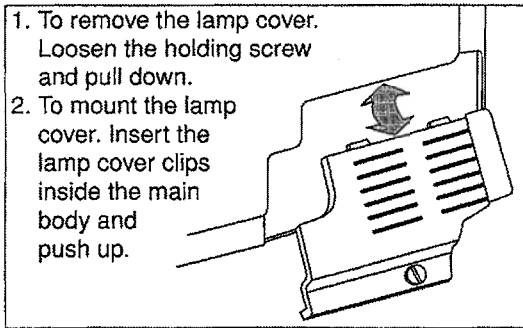

- (2) Loosen and take off the Xenon lamp fixing screw (A) on the lower portion of the body, then tighten this screw (A) into the hole (C) on the side of the Xenon lamp.

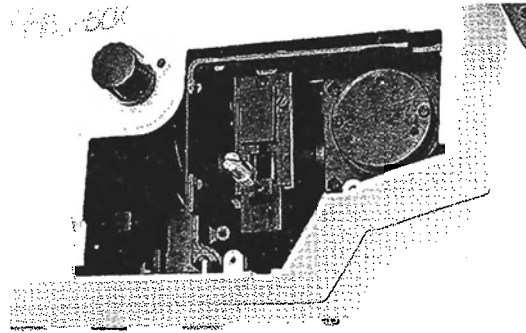
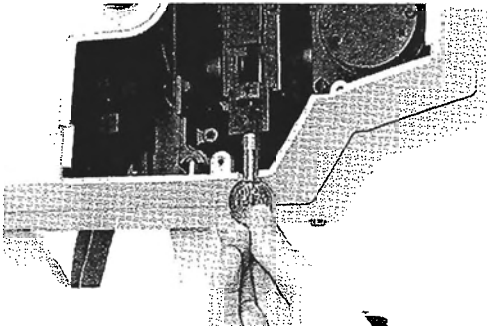
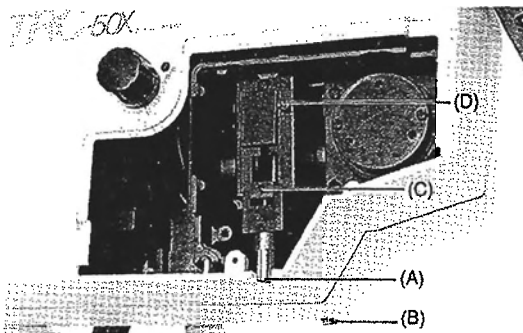

- (3) Loosen the Xenon lamp fixing screw (B).
- (4) Loosen the Xenon lamp cover screw (D), and slide this cover to right side.

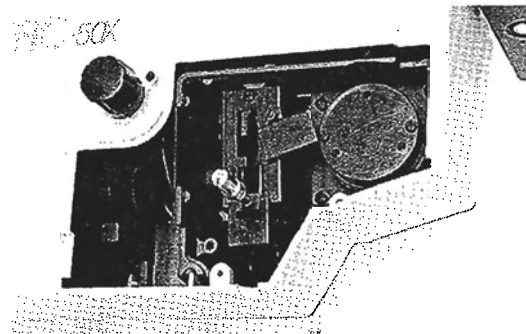

- (5) Remove the Xenon lamp unit from the socket while holding and raising the loosened screw (B).

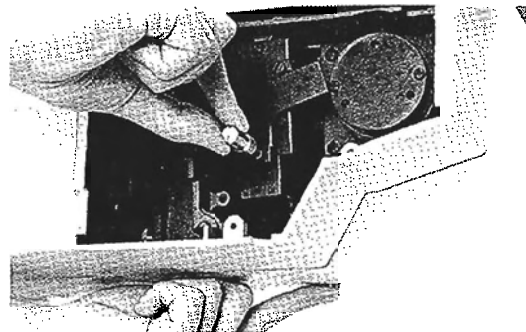

- (6) Grasp the screw (A) on the side of Xenon lamp and pull it straight out.

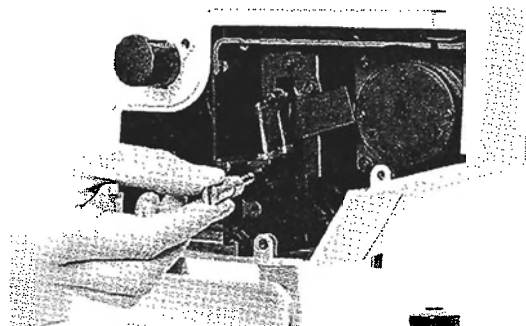

- (7) Insert the new Xenon lamp straight in the receptacle and touches it the end.
- (8) Loosen and take off the Xenon lamp screw (A) from the old Xenon lamp unit.
- (9) Tighten two Xenon lamp fixing screws (A) and (B) on the bottom of the body cover in the clockwise direction with coin.
- (10) Fix the Xenon lamp cover into the original position and tighten the cover screw (D).

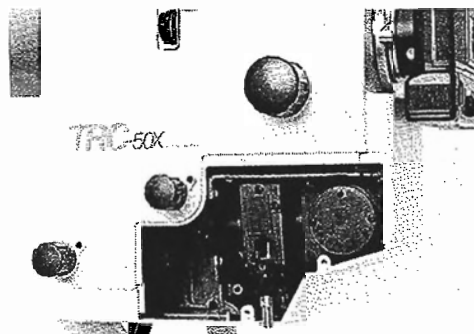

- (11) Attach the lamphouse cover ⑪ and tight the lamphouse cover screw.

#### 4.4 Changing the fuses

- (1) Check that illumination on the control unit has been turned off.
- (2) While pressing the fuse holder, remove it by rotating in the counter-clockwise direction.
- (3) Replace with a fuse of the same rating. While pressing the fuse holder, attach by rotating in the clockwise direction.

Fuse No.	Use	When the fuse blows
F1 (15 or 8A)	Power input	Instrument will not work
F2 (15 or 8A)	Power input	Instrument will not work
F3 (3.15A)	Flash control	The buzzer keeps sounding and the system does not operate.
F4 (4A)	Control circuit	The buzzer keeps sounding and the system does not operate.
F5 (5A)	Control circuit	The system does not operate.

#### 4.5 Schedule of expendables and accessories

When ordering spare parts, please indicate the code number and the quantity required, in addition to the description.

	Description	Code Number
Expendable supplies	Xenon lamp	4053540100
	Illumination lamp	4053540200
	Chinrest paper	4031040821
	Data plate	4040516040
Spare parts	Fuses (F1) (F2) 15A	4040558050 for 120V
	Fuses (F1) (F2) 8A	4040558060 for 220V & 240V
	Fuse (F3)	4053552090
	Fuse (F4)	4054753040
	Fuse (F5)	4040558070

## 5. BEFORE REQUESTING SERVICE—TROUBLE SHOOTING GUIDE

- (1) If any trouble should occur, check the following items before contacting your authorized dealer or TOPCON.
- (2) Pull out the power plug from the power outlet when lamps or fuses are to be checked.

Troubles	Check Points
1) Illumination lamp does not light	<ul style="list-style-type: none"> <li>* Has the power saving function been activated and the mode UPPER/LOWER selector ③ flickering illuminates? If so, press the UPPER/LOWER selector ③.</li> <li>* Check fuses F1 and F2.</li> <li>* Check whether the fixing screw of the illumination lamp is tightly screwed in.</li> <li>* Check whether the lamp has been used for more than its normal servicelife (1,000 hours).</li> </ul>
2) Xenon lamp does not flash	<ul style="list-style-type: none"> <li>* Has the power saving function been activated and the UPPER/LOWER selector ③ flickering illuminates? If so, press the UPPER/LOWER selector ③.</li> <li>* Check fuses F1, F2 and F3.</li> <li>* Is the non-flash switch ⑤ of control unit depressed?</li> <li>* Is the UPPER camera selection switch ⑥ set on "SV2"?</li> <li>* Is the motor drive switch ④ of 35mm camera OFF?</li> <li>* Is the Xenon lamp firmly in place?</li> <li>* Has the Xenon lamp been used more than its normal service life (10,000 flashes)?</li> </ul>
3) External fixation target does not light.	<ul style="list-style-type: none"> <li>* Check fuses F1, F2 and F5.</li> </ul>
4) 35 mm LOWER Camera does not work.	<ul style="list-style-type: none"> <li>* Has the power saving function been activated and the UPPER/LOWER selector ③ flickering illuminates? If so, press the UPPER/LOWER selector ③.</li> <li>* Check fuses F1, F2, F3, F4 and F5.</li> <li>* Check whether the motor drive switch ④ is set to "ON". (If the camera does not work when set to ON, switch "OFF" once and then switch "ON" once more.)</li> <li>* Check whether the UPPER/LOWER selector ③ of control unit is set to "LOWER".</li> <li>* Check whether the 35mm camera is securely attached.</li> </ul>
5) 35mm UPPER camera does not work	<ul style="list-style-type: none"> <li>* Has the power saving function been activated and the UPPER/LOWER selector ③ flickering illuminates? If so, press the UPPER/LOWER selector ③.</li> <li>* Check fuses F1, F2, F3, F4 and F5.</li> <li>* Check whether the UPPER/LOWER selector ③ of control unit is set to "UPPER".</li> <li>* Check whether the 1X relay lens is attached firmly.</li> <li>* Check whether the camera is attached firmly to the relay lens.</li> <li>* Check whether the 35mm lower camera is fixed to the optical head.</li> <li>* Check whether the UPPER camera selection switch ⑥ been set for the "35mm".</li> </ul>
6) Polaroid Attachment does not work or photography is not possible.	<ul style="list-style-type: none"> <li>* Has the power saving function been activated and the UPPER/LOWER selector ③ flickering illuminates? If so, press the UPPER/LOWER selector ③.</li> <li>* Check fuses F1, F2, F3, F4 and F5.</li> <li>* Check whether the UPPER/LOWER selector ③ of control unit is set to "UPPER".</li> </ul>

	<ul style="list-style-type: none"> <li>* Check whether the Polaroid Attachment is securely attached on the accessory mount.</li> <li>* Check whether the 35mm lower camera is fixed to the optical head.</li> <li>* Check whether the UPPER camera selection switch ③⑩ been set for the "POLA".</li> <li>* Check whether the Polaroid film is loaded in the Polaroid Attachment.</li> </ul>
7) No image on monitor screen when video relay lens adapter attached on the main body.	<ul style="list-style-type: none"> <li>* Has the power saving function been activated and the UPPER/LOWER selector ③⑪ flickering illuminates? If so, press the UPPER/LOWER selector ③⑪.</li> <li>* Check fuses F1, F2, F4 and F5.</li> <li>* Check whether the UPPER/LOWER selector ③⑪ of control unit is set to "UPPER".</li> <li>* Check whether the UPPER camera selection switch ③⑩ been set for the "TV".</li> <li>* Check whether the 35mm lower camera is fixed to the optical head.</li> </ul>
8) Counter does not work	<ul style="list-style-type: none"> <li>* Check fuses F1, F2 and F5.</li> </ul>
9) Timer does not work	<ul style="list-style-type: none"> <li>* Check fuses F1, F2 and F5.</li> </ul>
10) Exposure counter does not light.	<ul style="list-style-type: none"> <li>* Check fuses F1, F2 and F5.</li> <li>* Is the motor drive switch ④③ ON?</li> </ul>
11) Fluorescein filters do not work.	<ul style="list-style-type: none"> <li>* Check fuses F1, F2, F4 and F5.</li> </ul>
12) When flare can not be eliminated at the 50° coverage	<ul style="list-style-type: none"> <li>* Check whether the angle changing lever ① is properly positioned at 50° or 35° or 20°.</li> <li>* Check whether the illumination diaphragm knob ⑤ is set to "S" or "FP".</li> <li>* Check whether the patient's eye and optical head are properly positioned.</li> <li>* Is the patient's eye fully dilated?</li> </ul>
13) Correct focus is not possible.	<ul style="list-style-type: none"> <li>* Check whether the eyepiece ③⑦ is properly adjusted for the user's eyesight.</li> <li>* Check whether the diopter compensation knob ② is properly adjusted for the patient's dioptric power.</li> <li>* Check whether the patient's eye is clouded, due to cataract or other diseases.</li> <li>* Check whether the patient's eye is filled with tear.</li> <li>* Check whether the patient's eye and optical head are properly positioned.</li> </ul>
14) Operator cannot see the patient's eye.	<ul style="list-style-type: none"> <li>* Check whether the illumination lamp is lighted or not.</li> <li>* Check whether the cap of the objective lens is on or not.</li> <li>* Check whether both barrier and excitation filters are set to "ON".</li> <li>* Check whether the UPPER/LOWER selector ③⑪ of control unit is set "UPPER" and UPPER camera selector switch ③⑩ is set on "TV" and "SV2".</li> <li>* Check whether the angle changing lever ① is positioned between settings or not.</li> <li>* Check whether diopter compensation knob ② is properly positioned.</li> </ul>

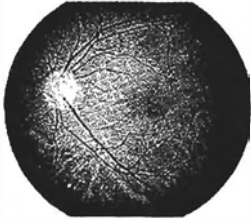
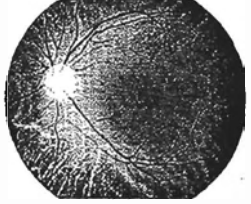
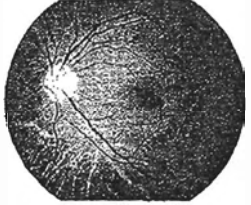
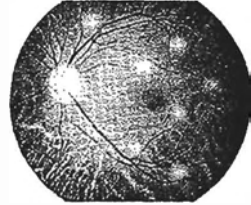
<p>15) Photograph of the retinal peripheries is dark.</p> 	<p>* Check whether the distance between the patient's eye and the main body is longer than 40mm working distance.</p>
<p>16) Photograph of retinal center is dark</p> 	<p>* Check whether the pupil of the patient's eye is dilated more than <math>\varnothing 6\text{mm}</math>.</p>
<p>17) Photograph is influenced by overall flare</p> 	<p>* Check whether the distance between the patient's eye and objective lens is shorter than the proper 39.9mm working distance.          * Check whether the illumination diaphragm knob ⑤ is set on "S", "FP", when set for the 50° angle of coverage.          * Check whether the light is too intense for photography.</p>
<p>18) Vague white dots are seen through the finder and also been photographed</p> 	<p>* Check whether there are tears on the patient's eye and on the objective lens surface.          (Note: See Clause 4.2 "Cleaning the objective lens" page 22.)</p>
<p>19) A continuous "beep" sound is heard</p>	<p>* Check the timer display inside the finder.          * When "-7-" is displayed:          Is the filter switching knob ④ stopped halfway?          * When "-3-" is displayed:          The system's condition is abnormal. Immediately turn off the power switch ⑤ and pull off the power cord. Then, call your dealer and tell the number on the display.</p>
<p>20) A continuous "beep" sound is heard and the EXCITER switch ⑤ blinks.</p>	<p>* The system's condition is abnormal. See the finder and confirm the number displayed on the timer (-4-, -5- or -6-).          Turn off the power switch ⑤ and pull off the power cord, and then call your dealer and tell the number on the display.</p>

## 6. SPECIFICATIONS

Angle of coverage:	50°, 35° and 20°
Working distance:	40mm
Area photographed:	26mm diameter (22mm on short side) on 35mm film.
Photographic magnifications :	
With 35mm camera at zero diopter:	1.8X at 50°, 2.5X at 35° and 3.7X at 20°
Total observation magnification (at zero diopter):	10X at 50°, 13.4X at 35° and 19.9X at 20°
Diopter compensation range for patient's eye:	
0 setting:	-10 to +6 diopter
+ setting:	+5 to +23 diopter
- setting:	-23 to -9 diopter
A setting:	Ocular anterior photography (+22 to +41 diopter)
Astigmatic correction range:	
3D rotating angle:	180°
6D rotating angle:	180°
Filters:	
Fluorescein photography:	Spectrotech type interference filters
Red free photography:	Green filter
Others filters:	Two blank settings for inserting filters of user's choice.
Illumination diaphragm:	Three step (N, S, FP) changing system for patient's pupil size.
Data photography:	Hand written data, exposure number or time can be selected. (When setting the ID mode, choose either 12-digit data, hand written data or time.)
Base movements:	
Coarse:	80mm longitudinally; 110mm laterally.
Fine:	12mm cross-slide adjustment
Optical head swing:	Up to $\pm 30^\circ$ of the arc lateral swing
Optical head vertical travel:	30mm (15mm up; 15mm down)
Optical head tilt w/tilt:	15° up; 10° down
Base movement for stereo photography:	$\pm 1$ mm laterally.
Chinrest vertical travel:	80mm
Light source:	
For observation:	12V 100W halogen lamp
For photography:	Max. 300WS Xenon lamp; adjustable in 9 steps
Charging time:	1 second
Fixation target:	External fixation target (Can be changed flickering illuminates and continuous illumination.)
Power supply unit:	AC 120V, AC 220V and AC 240V, adjustable with voltage selector 50/60Hz
Power consumption:	NORMAL 100VA MAX. 1500VA
Size (Main body):	340(W) x 503(D) x 630(H) mm
Weight (Main body):	42 Kg

\* Subject to changes in design and/or specifications without advance notice.

## 7. OPTIONAL ACCESSORIES

TOPCON optional accessories increase the range of photography possible with the models TRC-50X.

- \* Polaroid Attachment PA-50XC  
For providing instant color photographs.
- \* Polaroid Attachment PA-50XF  
For providing instant fluorescein black and white photographs.
- \* 1X Relay Lens Adapter  
Used when mounting the UPPER 35mm camera. With this adapter, two types of film can be used which are changed by the UPPER/LOWER selector ⑬.  
For example:
  - 35mm LOWER camera for fluorescein photograph by black and white film
  - 35mm UPPER camera for normal color photograph by color film
- \* Video Relay Lens Adapter  
Used when a video camera is mounted. The retinal image can be observed on the monitor screen and recorded on video camera. Also while watching the image on the monitor screen, by pressing the shutter release button ⑬, photography with the 35mm LOWER camera is possible.

- \* Internal Fixation Target  
This device is essential for examining photo-coagulation and amblyopia. The device can guide the eye to the points which is impossible with the external fixation target.
- \* Observation Tube  
Showing the same field of view observed by the view finder. Therefore teaching can be conducted under simultaneous observation.

### [NOTE]

- \* When attaching each accessory, make sure of the connector position and mount it straightly from above. When removing the accessory, lift it straightly upward. Do the operation carefully as improper mounting/dismounting may break connector pins.
- \* When mounting/dismounting an accessory, lock the tilting unit. If not, the mirror body will rise when the accessory is removed, or, when mounting, the mirror body moves independently and makes the operation difficult.

### 7.1 Polaroid Attachment PA-50XC

#### 1. Nomenclature

- A. Cap
- B. Locking ring
- C. Connector
- D. Mount
- E. Picture counter
- F. Film eject button
- G. Polaroid camera back
- H. Film door latch
- I. Film exit slot

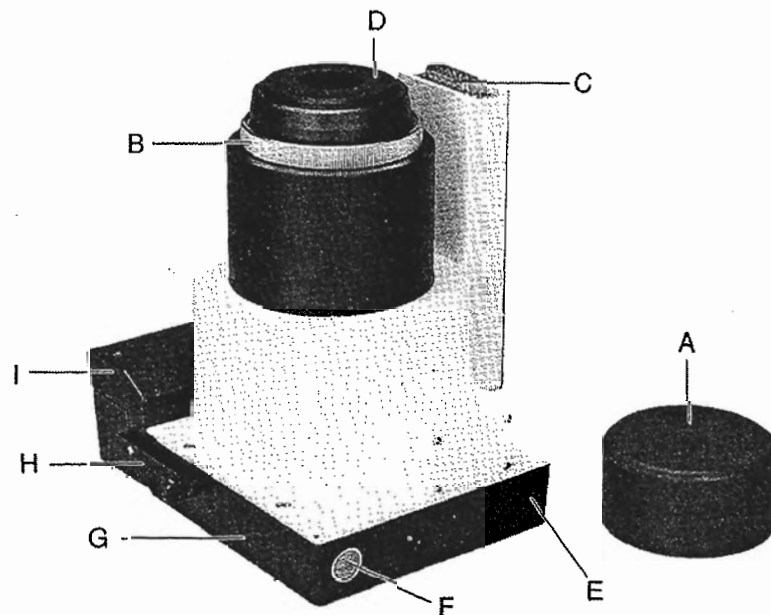



## 2. Attaching the Model PA-50XC to the Optical Head

- (1) Remove the accessory mount cap ⑭.
- (2) Lock the tilting device with tilt brake knob ⑰.
- (3) Mount the Model PA-50XC to the optical head. Match the mount [D] and connector [C] while pushing downwards, lock the attachment into place by tightening the locking ring [B]. If the film pack is not inserted properly, it will not be possible to close the film exit slot.

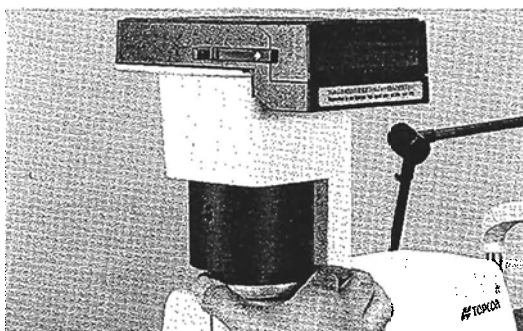

## 3. Procedures for Taking Polaroid Photographs

- (1) Set the UPPER camera selection switch ⑳ of control unit to "POLA".

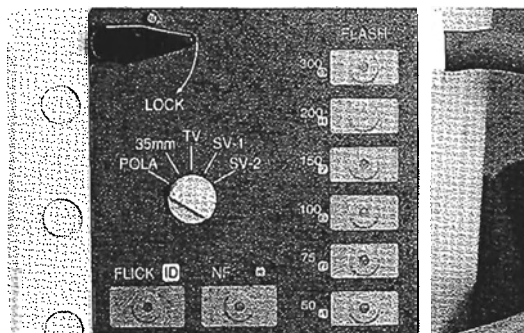

- (2) Set the UPPER/LOWER selector ㉑ of control unit to upper.

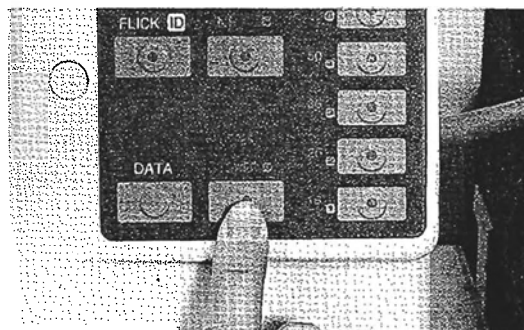

- (3) Load the Polaroid film pack.
  - \* Push the film door latch [H] in the arrow-indicated direction, and the film exit slot [I] will open.
  - \* Insert the film pack fully, with the battery contacts on the film pack pointing upwards. Then close the film exit slot

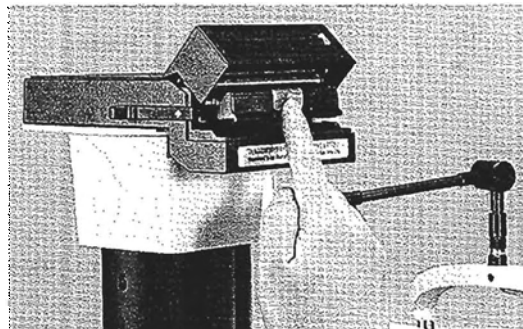

- \* Depress the film eject button [F] once and eject the backing paper. Do not use the shutter release button ㉒ to eject the backing paper but only the film eject button [F].

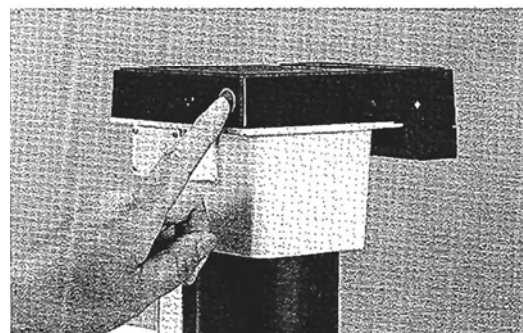

- (4) Set the flash intensity switches ㉓, based on the film being used and the structure being photographed.

Film	Flash Intensity
Polaroid 778	200WS
Polaroid 779	50WS

- (5) Alignment and photography are same as for normal retinal photography. By depressing the shutter release button ㉒ of the control lever, the film is ejected automatically.
- (6) Development of the Polaroid film takes from 3 to 5 minutes, although it can be viewed in about a minute.

- (7) One Polaroid film pack contains 10 sheets of film. The number of unexposed sheets remaining is displayed by the picture counter [E].
- (8) To exchange the film pack, push the film door latch [H] in the direction indicated by the arrow. The film exit slot [I] will open and the empty film pack will be ejected.
- (9) When the picture counter [E] indicates "O", a warning buzzer will sound. In order to stop the warning buzzer, pull out the film pack or set the UPPER/LOWER selector ③ to LOWER or set the UPPER camera selection switch ④ except "POLA".
- If the film pack is taken out and re-insert-

ed while photographing, even when there is no remaining film, the buzzer does not sound.

### Specifications

Angle of coverage:

50°, 35° and 20°

Area photographed on film:

74mmø x 62.6mm

Photographic magnifications:

5.3X at 50°, 7.0X at 35° and

10.4X at 20°

Film used: Polaroid Type 778 & 779

Dimensions: 155(W) x 130(D) x 176(H) mm

Weight: 1.7 kg

## 7.2 Polaroid Attachment PA-50XF

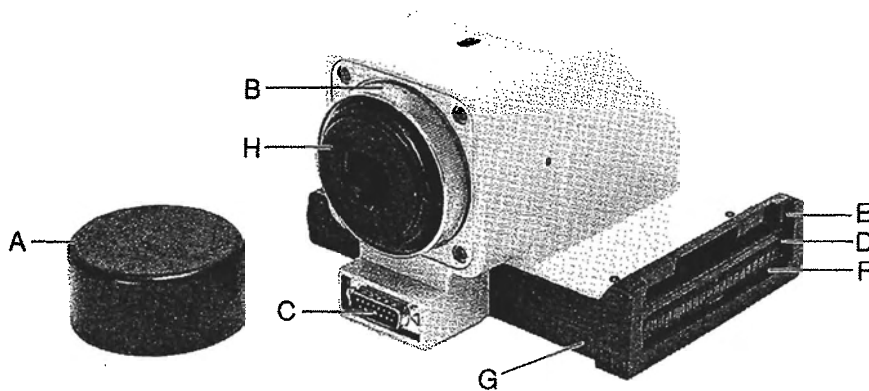

### 1. Nomenclature

- A. Cap
- B. Locking ring
- C. Connector
- D. Backing paper exit
- E. Hook
- F. Film exit
- G. Polaroid back
- H. Mount

### 2. Attaching the Model PA-50XF to the Optical Head

- (1) Remove the accessory mount cap ⑭.
- (2) Lock the tilting device with tilt brake knob ⑮.
- (3) Mount the Model PA-50XF to the optical head. Match the mount [H] and connector [C] while pushing downwards, lock the attachment into place by tightening the locking ring [B].



### 3. Procedure for Taking Polaroid Fluorescein Photographs

- (1) Set the UPPER camera selection switch ⑩ of control unit to "POLA".
- (2) Set the UPPER/LOWER selector ⑪ of control unit to "UPPER".
- (3) Load the Polaroid film pack.
  - \* Remove the hook [E] open the lid and load the film.
  - \* After closing the lid and locking the hook [E], pull out the white tab from the backing paper exit.
- (4) Set the flash intensity switch ⑫ according to the film being used and structure being photographed.

Film	Flash Intensity
Polaroid Type 667 (ISO(ASA) 3000)	300WS

- (5) Set the illumination diaphragm knob ⑬ to "FP".

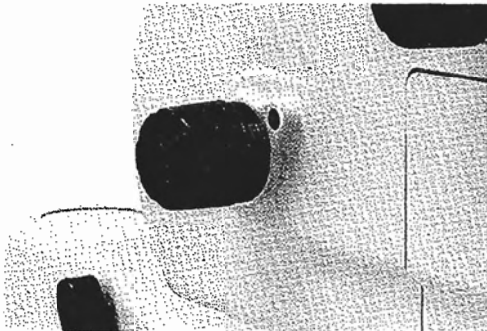

- (6) Alignment and photography are same as for normal retinal photography. By depressing the shutter release button ⑭ of the control lever, photograph can be taken.
- (7) Pull out the film.
  - With the Model PA-50XF, the film is not ejected automatically. Pull strongly on the white tab sticking out from the back-

ing paper exit [D] and the yellow tab of the printing paper will come out from the film exit [F].

The exposed film must be removed after taking each picture, as otherwise double exposure will take place.

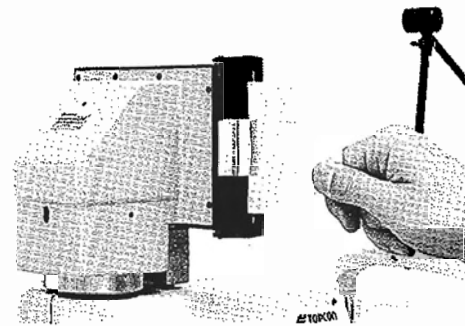
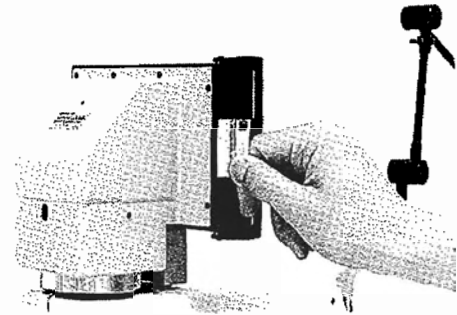

- \* With the Model PA-50XF, a warning buzzer will not sound, even when all the films are ejected.
- (8) As the development time of the film will differ, depending on the ambient temperature, please follow the instructions supplied with the Polaroid film.
  - (9) One Polaroid film pack contains 8 sheets of film.
    - For replacing the film pack, unlock the hook and open the cover, then insert a fresh pack.

### 4. Procedure for Taking Normal Black & White Photography

Procedures for photographing are the same as for normal fluorescein photography. Set the flash intensity switch ⑫ as the following table. And turn the illumination diaphragm knob ⑬. After photographing, pull out the film.

Film	Flash Intensity	Filter
Type 667	25WS	N (Normal)
ISO (ASA) 3000	100WS	G (Green)

### Specifications

Angle of coverage:

50°, 35° and 20°

Area photographed on film:

74mmø x 62.6mm

Photographic magnifications:

5.3X at 50°, 7.0X at 35° and

10.4X at 20°

Film used: Polaroid Type 667

Dimensions: 175(W) x 115(D) x 165(H) mm

Weight: 1.7 Kg

### 7.3 1X Relay Lens Adapter

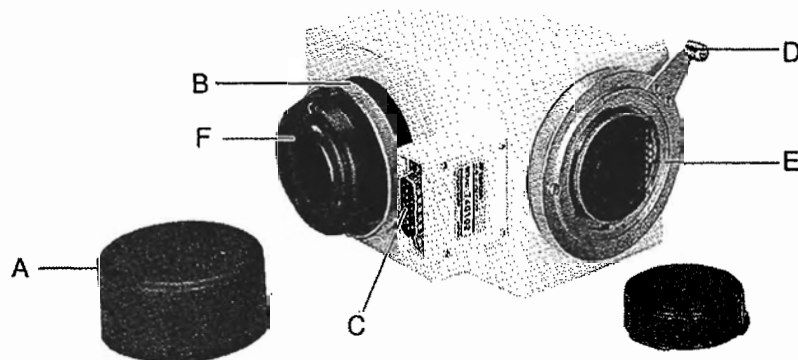

#### 1. Nomenclature

- A. Mount cap
- B. Locking ring
- C. Connector
- D. Camera locking lever
- E. 35mm camera mount
- F. Mount

#### 2. How to attach the 1X Relay Lens Adapter to the Optical Head

- (1) Remove the accessory mount cap ⑭.
- (2) Attach the 1X relay lens adapter to the optical head.  
Lock the tilting device with the tilt brake knob ⑰.  
Align the mount [F] and connector [C] with corresponding points on the optical head.

Next, press the 1X relay lens adapter strongly against the optical head and screw in the locking ring [B] until it is locked firmly.



(3) Attach the 35mm camera body to the 35mm camera mount [E].

Set the photography speed selector ④⑦ to "S".

Turn the camera locking lever [D] in the clockwise direction until it stops. Align the red mark of the camera mount ④⑨ and the red mark of the 35mm camera mount [E], next press the 35mm camera against the 1X relay lens adapter and turn the camera locking lever [D] in the counter-clockwise direction firmly and fix it.

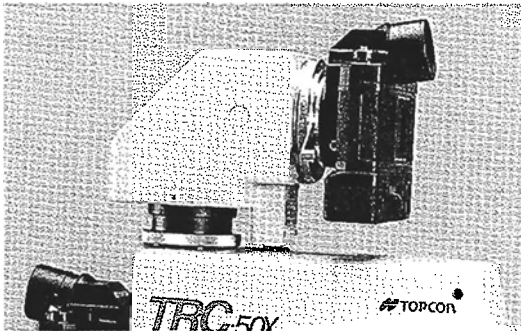

### 3. Procedures for Taking Photographs

(1) Set the UPPER camera selection switch ③⑩ to 35mm.

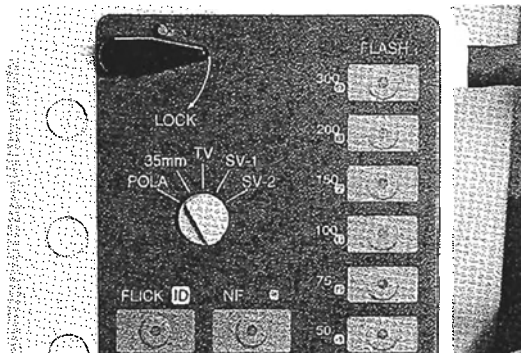

(2) Depress "35MM UPPER" of the UPPER/LOWER selector ③⑪.

(3) Depress the flash intensity switch ③⑫, suitable for the ISO (ASA) film speed.

(4) Alignment and focusing of the retina is through the view finder on the 35mm lower camera. Procedures for photographing are the same as for normal color photography with the 35mm lower camera.

The 1X relay lens adapter cannot be used for rapid sequence photography but only for photography at a maximum speed of 1 frame per second or single frame exposure. For photographing, set the photography speed selector ④⑦ to "S" and depress the shutter release button ⑬.

### 4. Specifications

Angle of coverage:

50°, 35° and 20°

Area photographed on film:

26mmø x 22mm

Photographic magnifications at 0 diopter:

1.8X at 50°, 2.5X at 35°

and 3.7X at 20°

Frame number can be photographed simultaneously.

Dimensions: 115(W) x 137(H) x 140(D) mm

Weight: 1.7 Kg

## 7.4. Video Relay Lens Adapter

### 1. Precautions and suggestions for use

(1) This Instruction Manual commonly deals with the single chip 2/3", three-chip 2/3" and three-chip 1/2" video relay lenses. So, be sure about the video camera used.

(2) Recommended video cameras:

Single chip 2/3".....SONY XC-77 (black and white)

Three-chip 2/3".....SONY DXC-750MD (color)

Three-chip 1/2".....SONY DXC-930 (color)

Single chip 2/3 inch

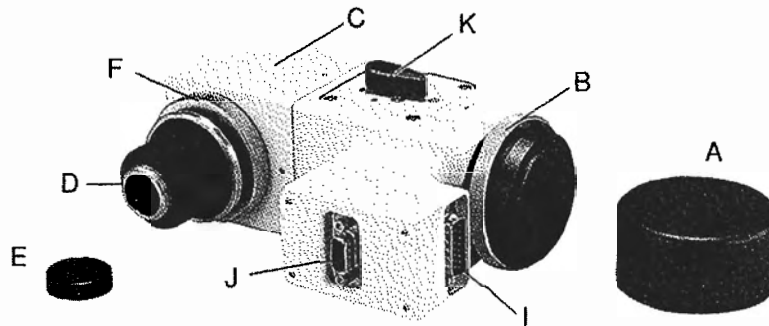

Three chips 2/3 inch

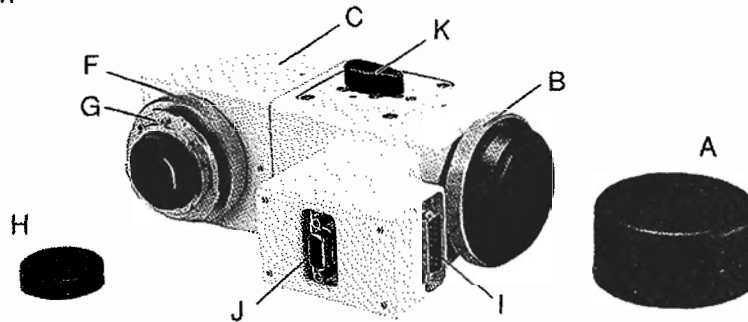

Three chips 1/2 inch

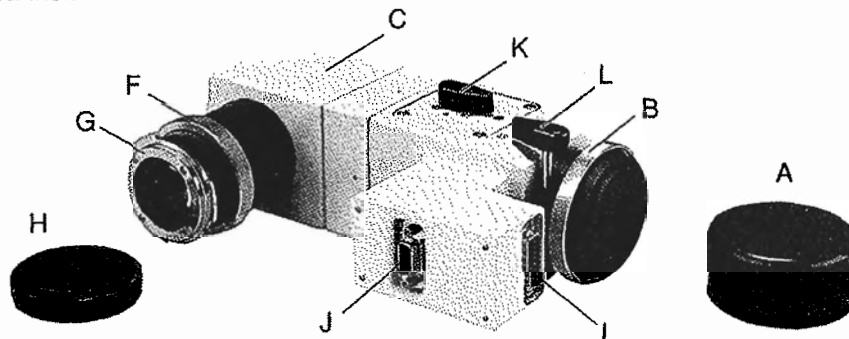

### 2. Nomenclature

- |  |                                 |
|--|---------------------------------|
| A. Cap                                 | G. Bayonet mount                |
| B. Locking ring                        | H. Bayonet cap                  |
| C. Video relay lens adapter, main body | I. 15P connector                |
| D. C-mount adapter                     | J. 9P connector                 |
| E. C-mount cap                         | K. Filter for color photography |
| F. Mount locking ring                  | L. Image angle selector lever   |

### 3. How to Attach the Video Relay Lens Adapter to the Optical Head

- \* For single chip 2/3 inch video camera
- (1) Remove the cap ⑭ and fix the video relay lens adapter [C] with the locking ring [B].



- (2) Turn the mount locking ring [F] and remove the C-mount adapter [D] from the video relay lens adapter [C].

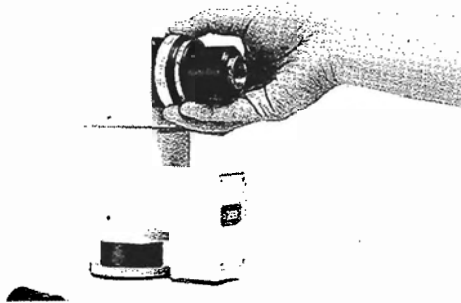

- (3) Attach the C-mount adapter [D] to the video camera mount. The video camera must be attached upside down in which condition, the image on the monitor will be correct.
- (4) Screw in the mount locking ring [F] of the video relay lens adapter [C].

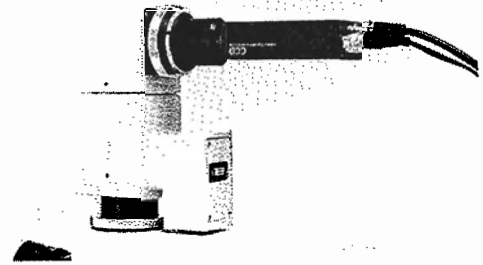

- \* For three chips 2/3 inch video camera
- (1) Remove the cap ⑭ and fix the video relay lens adapter [C] by turning the locking ring [B].

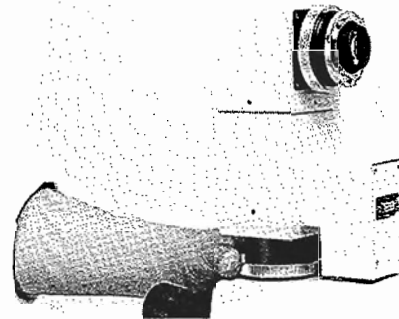

- (2) Align the pin of the bayonet mount [G] with the bayonet groove of video camera body and screw in the bayonet mount and fit into place.

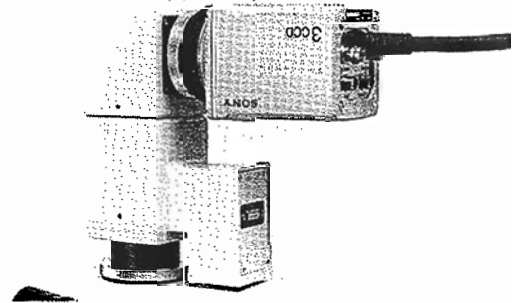

- \* For three-chip 1/2" video camera
- (4) Align the video camera's bayonet groove with pins of the bayonet mount (G) of the video relay lens unit (C) and tighten the bayonet mount.
- \* Set the image angle selector lever (L) of the video relay lens to 50° or 35° according to the photography image angle. Do not use the image angle 20° as it causes uneven color distribution.

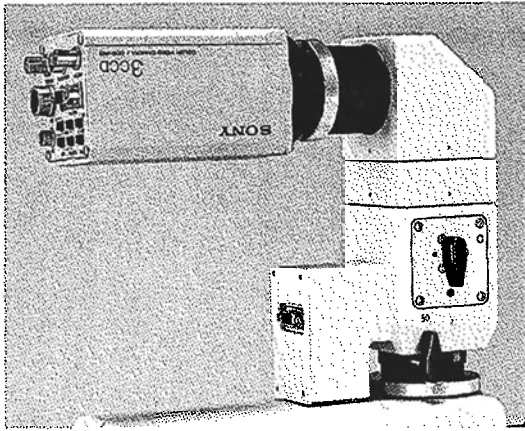

\* How to Attach the Cable Holder

- (1) Fix the cable holder base to the edge of the table surface, at a location which will not limit movements of the instrument, and insert the cable holder.
- (2) Fix the video camera cable to the cable holder, with sufficient slack in order not to limit movement of the optical head.

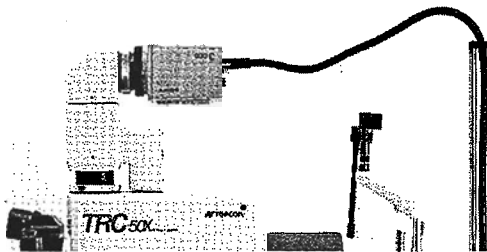

4 How to Use the Video Relay Lens Adapter.

1. Observation through the video camera
  - (1) By selecting "TV" on the UPPER camera selection switch ⑩ and setting the UPPER/LOWER selector ⑪ to "UPPER", the retinal image will appear on the monitor screen.



With TV selected and the UPPER/LOWER selector ⑪ set on UPPER, by

pressing the shutter release button ⑬, the retinal image can be photographed by the 35mm camera.

- (2) Adjust proper focus and correct optical axis while watching through the monitor screen.
- (3) A brighter illumination is required for video recording, in comparison with the normal illumination for observation. On the other hand, the illumination should not be made too bright, as this will overtax the patient and cause tears to appear in the patient's eye, with the result that a good retinal image will not be obtained. In other words, the brightness must be properly adjusted.

2. Still Video Photography

In the case of SV1

- (1) Select "SV1" on the UPPER camera selection switch ⑩, and set the UPPER/LOWER selector ⑪ on "UPPER".

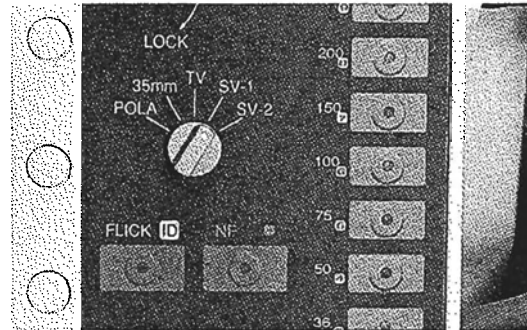

Setting the still video.

Connect the 9P connector [J] of video relay lens adapter and interface of the still video with the coaxial cord (optional accessory).

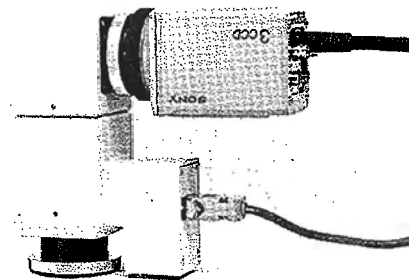

- (2) Look through the 35mm camera finder to adjust focus and to adjust the optical axis.



In the case of regular color photography, set the video: The color filter [K] of video relay lens adapter to ON. Be careful that if you take the photograph with the filter [K] left on OFF, the photograph will result in one exposure.

- (3) Press the shutter release button ⑬ to record the retinal image onto the still video.

For illumination intensity, refer to the Exposure Guide on page 42. (However, only for cameras recommended by TOPCON.)

\* In the case of SV2

- (1) Select "SV2" on the UPPER camera selection switch ⑩ and set the UPPER/LOWER selector ⑪ on the "UPPER".

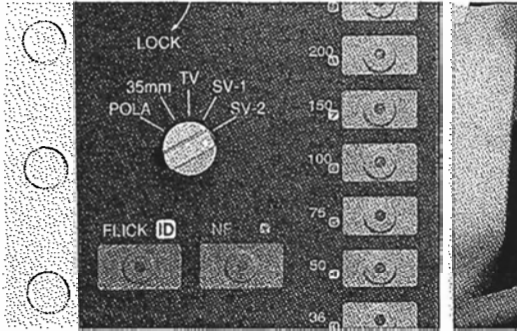

- (2) Adjust proper focus and correct optical axis while watching through the monitor screen.

- (3) Press the shutter release button ⑬ to record the retinal image on the monitor screen onto the still video.

## 5. Specifications

- (1) For single chip 2/3 inch video camera  
Camera tube: 2/3 inch  
Lens mount: C-mount  
Dimensions: 80(W)x125(D)x195(H) mm  
Weight: 1.6 Kg
- (2) For three chips 2/3 inch video camera  
Camera tube: Three-chip 2/3 inch  
Lens mount: Bayonet mount  
Dimensions: 80(W)x125(D)x195(H)mm  
Weight: 1.6kg
- (3) For three chips 1/2 inch video camera  
Camera tube: Three-chip 1/2 inch video camera  
Lens mount: Bayonet mount  
Dimensions: 80(W)x130(D)x220(H) mm  
Weight: 1.8 Kg

## 7.5 Internal Fixation Target

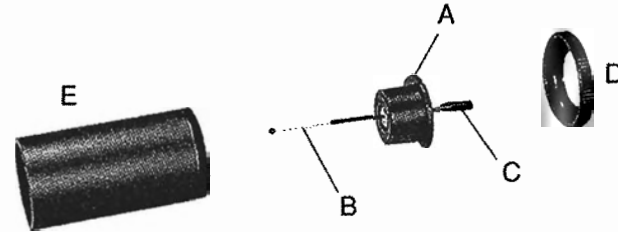

### 1. Nomenclature

- A. Fixation target
- B. Fixation point
- C. Knob
- D. Locking cap
- E. Protective cap

### 2. How to Attach the Internal Fixation Target

- (1) Take off the cover of the internal fixation target mount ⑦ on the optical head.

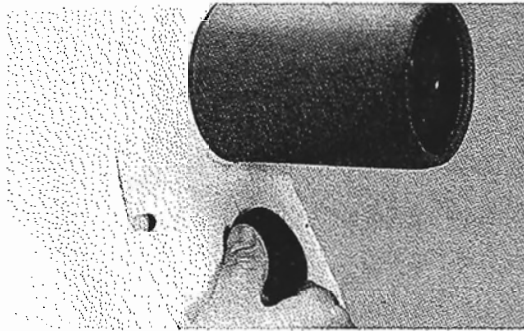

- (2) Take off the protective cap [E] align the fixation target [A] with pin of the internal fixation target mount ⑦ and insert straightly into the main body.

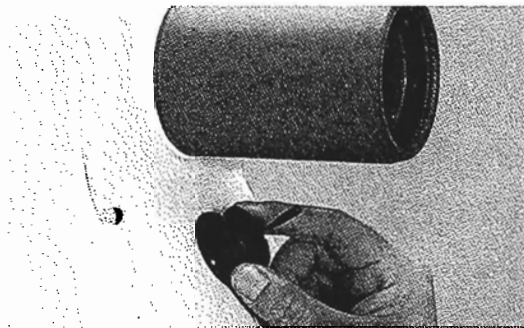

In the above case, great care must be exercised because the fixation point [B] is slender and easily bent. For attachment, the fixation point should be pulled out as fully as possible, and the mount should be screwed in slowly and carefully, with the fixation point maintained vertically. And, until the locking cap [D] is attached, the fixation point should not be moved.

- (3) Tighten the locking cap [D].

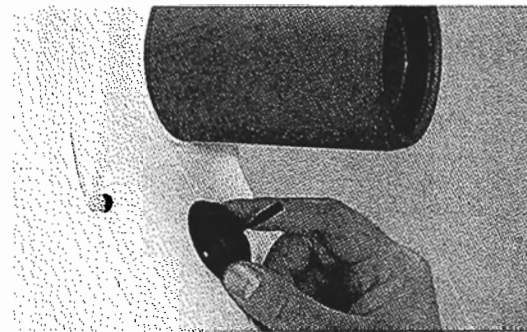

### 3. Operating procedures

- (1) Move the knob [C] and lead the patient's eye with the fixation point, while checking movement through the finder of the 35mm lower camera.

The knob moves in every direction. Up-and-down movement is used for obtaining proper focus, while right-and-left and back-and-forth movements are used to move the fixation point in the field of view. Movement should be done slowly, in order not to confuse the patient when leading the patient's eye.

## 7.6 Observation Tube

Precautions and suggestions for use  
Handle tube with care so that the exposed lens is not touched, as it is located near the focal surface. If the lens

is soiled accidentally, clean it according to the steps as given in Wiping Objective Lens on page 22.

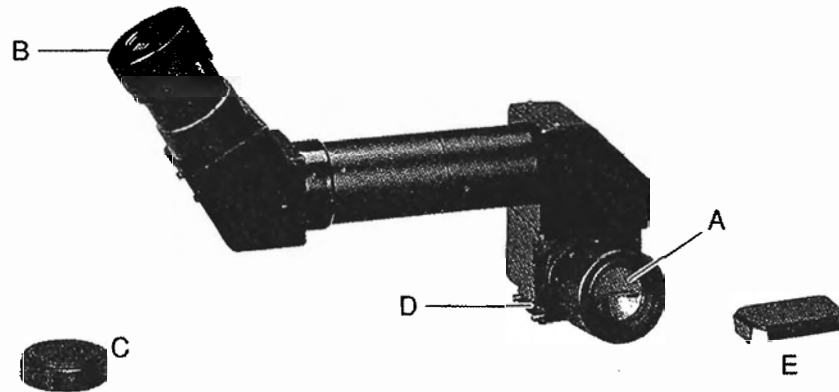

### 1. Nomenclature

- A. Eyepiece (for operator)
- B. Eyepiece (for observer)
- C. Eyepiece cap (for observer)
- D. Finder guide pin
- E. Prism cap

### 2. How to Mount Observation Tube to TRC-50X

- (1) Press finder attachment buttons  $\text{\textcircled{42}}$  on right and left sides of 35mm camera top and pull finder upward to remove it.



- (2) Match 35mm camera notch with finder guide pin [D] to push the tub in.  
**Warning:** Use care not to touch the exposed lens, otherwise observation will be affected.

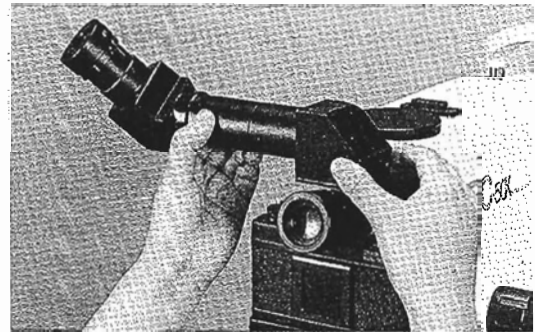

### 3. How to Use Observation Tube

- (1) Adjust eyepiece [A] for diopter.
  - (a) Bring white paper close to the retinal camera objective lens.
  - (b) Look through the finder, first draw out eyepiece [A] fully, then turn left gradually and stop where reticle is seen clearly for the first time in the finder field-of-view.
  - \* If eyepiece [A] is not well adjusted for diopter, focusing will be incorrect. Remember to adjust for diopter before photographing.
- (2) Adjust eyepiece [B] for diopter.

Adjust eyepiece [B] so that reticle is clearly seen in the finder field-of-view.

  - \* When eyepiece [B] is not used, be sure to cover it with eyepiece cap [C]. If not, light enters through eyepiece [B] affecting observation.

#### 4. Precautions for Fluorescein Observation

When eyepiece [B] is used for fluorescein observation, good observation at later stages of fluorescein may be difficult, since reflecting light flux from the retina is divided at a ratio of 7 [A] to 3 [B].

#### 5. Specifications

Observation magnification at 0 diopter:

Eyepiece [A] for operator:

At 50° – 10X

At 35° – 13.4X

At 20° – 19.9X

Eyepiece [B] for observer:

At 50° – 11.5X

At 35° – 15.3X

At 20° – 22.7X

Light quantity ratio by eyepiece:

7 [A]: 3 [B]

Weight: 0.8 Kg

## 8. EXPOSURE GUIDE FOR RETINAL CAMERA MODEL TRC-50X

Type of Photography	35mm Color			Polaroid			Fluorescein	Red-Free	Still Video Camera
	Type 667 Red free	Type 779 Color	Type 778 Color						
Control setting									
ISO(ASA) Film Speed	25	64	100	200	3000	640	150	400	
Flash Intensity Switch	150	50	36	18	300	50	200	18	36
Camera Selection	35mm				POLA			---	SV1
UPPER/LOWER Selector	Lower/Upper (1x Ray lens)				UPPER			LOWER	UPPER
Normal Color Photography Knob	2 - 3				2 - 3			---	2 - 3
Fluorescein Angiography Knob	---				---			4 - 5	---
Data Photography	DATA				---			DATA	

The indicated flash intensity setting is for the average pigmented retinal area.



75-1 Hasunuma-cho, Itabashi-ku, Tokyo, 174 JAPAN  
Phone: 3-3558-2520 Fax: 3-3960-4214

**TOPCON AMERICA CORPORATION**

CORPORATE OFFICE  
65, West Century Road, Paramus, New Jersey 07652, U.S.A.  
Phone: 201-261-9450 Fax: 201-387-2710 Telex: 134338

**ISELL DIVERSATRONICS INC.**

2430 Blvd. of the Generals, Valley Forge Business Center,  
Norristown, PA 19404, U.S.A.  
Phone: 610-630-9200 Fax: 610-630-6428

**TOPCON EUROPE B.V.**

Esse Baan 11, 2908 LJ Capelle a/d IJssel, THE NETHERLANDS  
Phone: 10-4585077 Fax: 10-4585045 Telex: 23783 TOPCON NL

**TOPCON S.A.R.L.**

104/106, Rue Rivay 92300 Levallois-Perret, FRANCE  
Phone: 1-4108 9494 Fax: 1-47390251 Telex: 620287 TOPCON F  
LYON OFFICE  
138, Avenue du 8 Mai 1945, 69100 Villeurbanne, FRANCE  
Phone: 78688237 Fax: 78681902

**TOPCON ESPAÑA S.A.**

Frederic Mompou, 5 08960, Sant Just Desvern Barcelona, SPAIN.  
Phone: 3-4734057 Fax: 3-4733932  
MADRID OFFICE  
Avenida Ciudad de Barcelona 81, 1 Planta 28007, Madrid, SPAIN.  
Phone: 1-552-4160 Fax: 1-552-4161

**TOPCON DEUTSCHLAND GmbH**

Haiskesir. 7, 47877 Willich, GERMANY  
Phone: 02154-9290 Fax: 02154-929111 Telex: 8531981 TOPC D  
TOPCON BÜRO HAMBURG  
Braamkamp 32, 22297 Hamburg, GERMANY  
Phone: 040-5110052 Fax: 517965  
TOPCON BÜRO HILDESHEIM  
Katharinenstr. 10, 31135 Hildesheim, GERMANY  
Phone: 05121-37451 Fax: 05121-15355  
TOPCON BÜRO FRANKFURT  
Berner Str. 62-64, 60437 Frankfurt, GERMANY  
Phone: 069-5076544 Fax: 069-5076763  
TOPCON BÜRO MÜNCHEN  
Guntherstr. 19, 80639 München, GERMANY  
Phone: 089-1784047 Fax: 089-170327

**TOPCON OPTICAL SVENSKA A.B.**

Industrivägen 4 P. O. Box 2140 43302 Sävedalen SWEDEN.  
Phone: 031-261250 Fax: 031-268607 Telex: 214114

**TOPCON SINGAPORE PTE. LTD.**

Alexandra Distripark Block 4, #05-15, Pasir Panjang Road, Singapore 0511  
Phone: 2780222 Fax: 2733540 Telex: 26622 TOPSIN

**TOPCON AUSTRALIA PTY. LTD.**

408 Victoria Road, Gladsville, NSW 2111 AUSTRALIA  
Phone: 02-817-4666 Fax: 02-817-4654

**TOPCON INSTRUMENTS (MALAYSIA) SDN. BHD.**

Lot 226 Jalan Negara 2, Pusat Bandar Taman Melawati, 53100 Kuala Lumpur, MALAYSIA  
Phone: 03-4079801 Fax: 03-4079796

**TOPCON INSTRUMENTS (THAILAND) CO., LTD.**

147/229-230, New Southern Bus Station, Pinklao-Nakornchaisri Rd  
Bangbunru, Bangplad, Bangkok 10700, THAILAND  
Phone: 02-435-4002 Fax: 02-435-4005

**TOPCON KOREA CORPORATION**

Hyobong Bldg., 1-1306, Seocho-Dong, Seocho-Gu, Seoul, KOREA  
Phone: 02-557-9231/2 Fax: 02-556-1928

**TOPCON OPTICAL (H.K.) LIMITED**

2-4/F., Meeco Industrial Building, 53-55 Au Pul Wan Street, Fo Tan Road, Shatin, N.T., Hong Kong  
Phone: 8049688 Fax: 6910264

**TOPCON CORPORATION BEIJING OFFICE**

Room No. 962 Poly Plaza Building, 14 Dongzhimen Nandajie, Dongcheng District, Beijing, 100027 CHINA  
Phone: 501-4191-2 Fax: 501-4190